

# Broadcast News

Volume No. 139, July 1968

# RCA

Best of Both Worlds



Best of Both Worlds





## Color Films Come Alive

... in their Original Brilliance  
with the RCA "Big Tube"  
Color Film System



The "Big Tube" concept in color film cameras assures reproduction of programs and commercials in all their original beauty. Film and slide subjects have the natural look of colors that are faithfully reproduced. Pictures are brilliant, films have snap and sparkle—to entertain, to educate, and to sell.

By using a Big Tube—50% larger than others use—RCA gives you greater resolution. It's like using a big negative in photography. The picture is sharper, the focus is uniform—all over the screen. Outdoor and indoor subjects, close-ups and macro-shots, all reflect the higher resolving power.

# **RCA** Broadcast News

---

Published by BROADCAST AND TELEVISION EQUIPMENT DEPARTMENT  
RCA COMMERCIAL ELECTRONIC SYSTEMS DIVISION

## CONTENTS

---

Yorkshire Television Builds A Colour Station . . . . .	5
KOB Radio and Television . . . . .	10
New UHF High-Gain Polygon Antenna . . . . .	19
Best of Both Worlds at NAB . . . . .	24
Professional TV Provides Another Choice . . . . .	30
Texas Style Color Bus for WBAP-TV. . . . .	36
WBRA (ETV) Finds Color Increases Attention . . . . .	38

---

PRICE . . single copies, \$2.50 each

*Copyright 1968 Radio Corporation of America. All Rights Reserved*



Andrew F. Inglis



Edwin C. Tracy



Andrew L. Hammerschmidt

### **BROADCAST SYSTEMS DEPARTMENT FORMED UNDER THREE-MEMBER MANAGEMENT TEAM**

A new Broadcast Systems Department which brings together broadcast equipment engineering, product management and sales activities was announced in April by Barton Kreuzer, Division Vice President and General Manager, Commercial Electronic Systems Division.

The new organization functions under a three-executive team headed by Andrew F. Inglis, a Division Vice President who has been responsible for engineering and product management activities for the past two years. Associated with him are Edwin C. Tracy, Division Vice President, Broadcast Sales, and Andrew L. Hammerschmidt, Division Vice President, Broadcast Engineering and Product Management.

Mr. Hammerschmidt, who has been Manager, Electronic Recording Products and Scientific Instruments, was promoted to Division Vice President coincident with his new responsibilities. Mr. Tracy has headed broadcast equipment sales since 1950 and was named a Division Vice President four years ago.

The new grouping of activities stems from a recognition that a more closely-knit organization will better serve a broadcast industry that recently has grown much larger and more diverse,

both in equipment needed and in the makeup of customer groups buying this equipment.

Centralizing such activities as policy-making, product planning and marketing under a single executive also is intended to strengthen the Division's ability to plan on a long-range basis, and make the organization more responsive to industry needs and trends.

Before joining RCA in 1953, Mr. Inglis was a partner with Frank H. McIntosh in a Washington, D. C. consulting firm to the radio and TV broadcast industry. He has held several executive posts, including responsibility for RCA's broadcast product development program and TV systems engineering.

Mr. Inglis also has been manager of RCA's closed circuit TV activities and for three years was operating head of the RCA engineering and manufacturing center for communications, audio visual and broadcast transmitter equipment at Meadow Lands, Pa. He has been a Division Vice President since 1963.

Mr. Tracy joined RCA in 1939 as a television engineer with the RCA Service Company. He transferred to broadcast equipment sales in 1946 and worked as a sales representative in Chicago. He

became Field Sales Manager in 1950.

Later Mr. Tracy was assigned overall sales responsibility for all major Division products, including closed circuit systems, scientific instruments and broadcast equipment sold to government.

Mr. Hammerschmidt, an executive with broad experience in network and station television and in broadcast equipment, joined the Commercial Electronic Systems activity in 1965 as Manager, Operations Plans. For the four previous years he had been Chief Engineer and later Manager, Program Operations, for the RCA Surface and Missile Radar Division.

Mr. Hammerschmidt began his company career in 1941 as an engineer at NBC and moved up through the ranks, becoming Vice President of Engineering and Facilities Administration in 1956.

During his NBC career he set up in 1948 the network's new TV station in Cleveland and became its Television Operations Supervisor.

Later he was Assistant Director, Color TV Systems Development, with the network and subsequently was named Associate Director, Technical Operations, a post in which he was responsible for all network TV operations in New York.



Riggers go aloft to check tower as station personnel (below) gather at transmitter.



## WPHL-TV FIRST WITH RCA 110-KW TRANSMITTER FOR 4.3 MILLION WATTS ERP

WPHL-TV, the U. S. Communications Corporation's Philadelphia outlet, became the nation's first "super-power" UHF station this Spring with initial operation of the first unit of RCA's new 110-KW transmitter. The system employs a 40-gain antenna to develop 4.3 million watts of effective radiated power.

During an inspection tour a few days before the "on-air" date, USC and RCA officials watched final stages of construction as the 15-ton antenna was hauled atop a 1,020 foot tower and bolted into place by a crew of dauntless and sure-footed riggers. The new facility is located in an antenna farm in Philadelphia's Roxborough section.

The Channel 17 installation marked the first of three planned by U. S. Communications for the three TTU-110 transmitters ordered from RCA. Others are scheduled for future operation at KEMO-TV, San Francisco, and WECO-TV Pittsburgh. The company also has UHF stations in Cincinnati, Atlanta and Houston.

The TTU-110A transmitter employs diplexed power amplifiers and new five-cavity, vapor-cooled klystrons with exceptionally high sensitivity. The one aural and two visual klystrons are identical tubes and are high-power versions of the integral-cavity, vapor-cooled types used in RCA 30 and 55-KW UHF transmitters. Other key features of the new 110-KW transmitter are solid state circuits, low profile styling and built-in provision for remote control.

In the accompanying photograph, one of the transmitter's big klystrons gets a send-off pat from the inspection group. From left, Dr. Frank Reichel, Jr., Board Chairman, USC; Leonard B. Stevens, Vice President, Operations; Robert Leach, Director of Engineering; Robert F. Doty, WPHL-TV General Manager, and Andrew L. Hammerschmidt, Division Vice President, Engineering and Product Management, RCA Broadcast Systems Department.

## WORLD'S LARGEST MOBILE RADIO NET OPENS IN N.Y.

The world's largest commercial two-way radio system, a communications network that will link 4,200 public buses with their headquarters, was placed in operation in May by the New York City Transit Authority. The \$4.2 million contract with RCA for the system's basic equipment was the largest ever awarded any manufacturer of non-military two-way radios.

It called for delivery of 4,772 Super-Fleetfone two-way radios of all-solid-state design, 253 portable two-way radios and a larger number of public address systems. The Authority had installed the radios in 2,500 buses by mid-May and plans to equip its entire fleet by the end of the year.

In addition to its size, the system is outstanding for its extensive use of battery power. The transistorized radios in the 19 base stations as well as those used in buses operate on 12-volt batteries, assuring uninterrupted service in the event of a power failure.

Principal uses of the system will be in controlling and re-routing buses, especially during heavy traffic and emergencies; serving as a crime deterrent, and providing information for passengers.

Bus drivers communicate with their headquarters, or with a supervisor carrying a portable radio at curbside, by lifting a telephone-type handset.

Driver uses handset to call headquarters.



Three of 19 consoles in net's big control center where backlighted maps show radio dispatcher the bus routes he covers.



Mary DePiano poses fetchingly against the skyline with one of the 252 hand-held two-way units used in New York system.

## RELIGIOUS BROADCASTER TRIPLES CAPACITY

A religious organization whose radio programs are broadcast worldwide from a station high in the Ecuador mountains is nearly tripling its capacity with the installation of four RCA 100-KW short wave transmitters.

The station, HCJB, is operated by the World Radio Missionary Fellowship, Inc., at a site near Quito, Ecuador, 8,500 feet above sea level. On the air since 1931, the station broadcasts from its five studios around the clock in the English, Russian, German, Swedish, Spanish, Portuguese and other languages and reaches listeners in approximately 100

countries. Steerable antennas are used to beam language broadcasts in a target country's direction, enabling the station to cover most countries on the globe.

Currently HCJB is capable of broadcasting on five frequencies simultaneously, with 30,000 watts of power on each frequency. Installation of the RCA transmitters will add 400,000 watts, giving the station the ability to increase program coverage by nearly three times.

Acquisition of the transmitters is part of an expansion program begun by the interdenominational missionary group several years ago.

Yorkshire Television Will Have  
First All Colour 625 Line Station  
In the United Kingdom

In February, 1967, the Independent Television Authority (ITA) invited applications for new programming contracts to provide seven day television service in the Midlands, Lancashire and Yorkshire. The successful applicant for the Yorkshire area formed a new company, Yorkshire Television Limited, to serve the Emley Moor transmitter of the ITA. The contract for broadcasting to the Yorkshire area was awarded on June 30, 1967, for an on-air date of July 29, 1968. Construction of the station buildings commenced on August 13, 1967 and installation of equipment began March 5, 1968. The estimated cost of the completed building and installation is approximately 1,500,000 pounds, including construction labor costs. Total equipment costs for the station will be an additional 2,000,000 pounds. The station will employ the European PAL (Phase Amplitude Line) colour system and when full colour operation is accomplished by the autumn of 1969, the Yorkshire Television studio center will be the first in the United Kingdom to have been designed as an all colour 625 line station.

## BUILDING A COLOUR TV STATION

P. G. PARKER, Chief Engineer, Yorkshire Television Ltd.

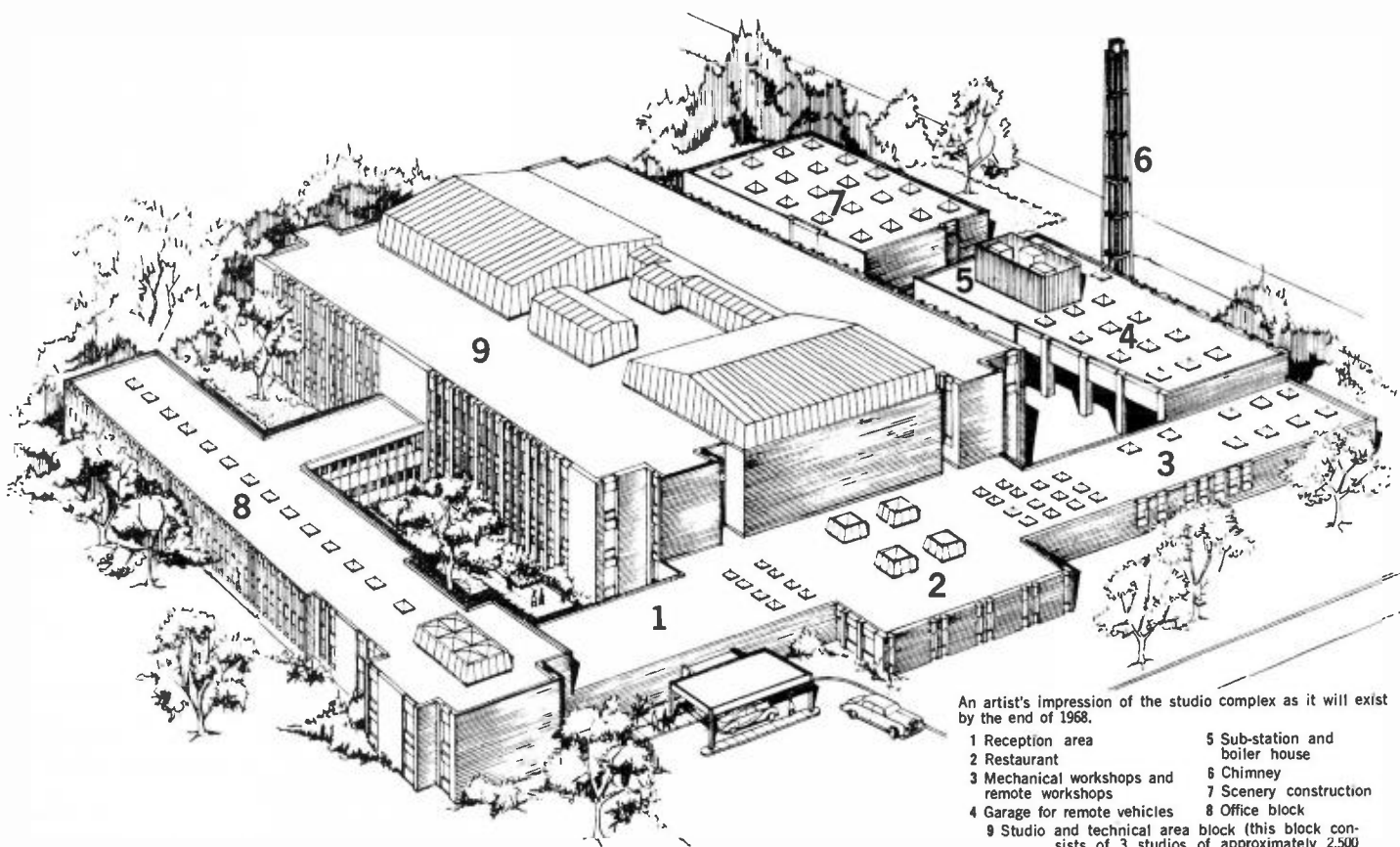

An artist's impression of the studio complex as it will exist by the end of 1968.

- |   |                                |
|---|--------------------------------|
| 1 Reception area  | 5 Sub-station and boiler house |
| 2 Restaurant  | 6 Chimney                      |
| 3 Mechanical workshops and remote workshops   | 7 Scenery construction         |
| 4 Garage for remote vehicles  | 8 Office block                 |
| 9 Studio and technical area block (this block consists of 3 studios of approximately 2,500 square feet and 8,000 square feet together with 2 small promotion studios) |                                |

## The Schedule

In order to go on the air at the scheduled time, the following areas had to be complete and fully operational in the three-story studio and technical area block: master control, presentation suite, two studios, television tape and television film, together with the necessary switching and auxiliary facilities to feed these areas. In conjunction with the production center, in February, 1968, a mobile unit equipped with a television tape machine was in operation, to ensure that a library of taped material could be developed for use when the studio center commenced broadcasting.

The introduction of an all colour commercial television station in the United Kingdom presented unique problems in engineering and planning that had to be solved at the site by Yorkshire Television personnel. One of these problems was in the area of live television production, both colour and black and white, as a method had to be developed for the match-



FIG. 1 Signing the contract for five RCA TR-50s and two RCA TR-70s. From left to right, standing: Mr. D. L. Hardman and Mr. G. L. Fosbrooke, RCA Great Britain Ltd., Mr. P. G. Parker, Yorkshire Television Ltd.; seated: Mr. W. L. Freebody, Managing Director, RCA Great Britain Ltd., Mr. G. E. Ward Thomas, D.F.C., Managing Director, Yorkshire Television Ltd.

ing of the sequences of different angle shots resulting from the use of several cameras on the same set. It was soon realized, as other broadcasters have already determined, that this problem of presenting a three dimensional scene from different viewpoints on a two dimensional static screen becomes even more acute in colour.

In order to establish the new techniques necessary to synchronize camera work and satisfactorily resolve

similar situations with regard to other equipments, Yorkshire Television evolved standardized disciplines and operational procedures to a high degree. Plans were formulated for centrally locating all control and switching equipment, including studio lighting consoles, so that production could be accomplished with operational adjustments kept to a minimum. Thus, it was agreed to centralize and "assign" equipment for specific functions and to integrate this philosophy into normal station operations.

## Assignment Switching Studies

Ideally, all equipment, audio, video and communications, should be capable of assignment, together with the appropriate controls, to wherever the operational load exists and in whatever grouping is needed at any particular instance. For example, live cameras, film chains, tape machines and other input sources should be made available to a studio to suit the particular production, provide film or slide inserts, and record the entire performance. Then the same tape and/or film units should be able to be switched, without involving any manual re-patching, at another period of the day for replay along the network.

Since the final plan selected had to provide optimum flexibility and reliability, several practical difficulties in completely achieving this objective, were examined in detail. It immediately became apparent that it would not be physically practicable, for example, to remotely assign the electronic camera heads and camera control units. So it was decided to have these be manually patched at the central apparatus area. Additional areas requiring the assignment of remote controls of various other colour equipment also required intensive study. Since Yorkshire Television's operational plans were to be based on an effective and economically viable system, controls had to be developed which, in physical appearance and apparent function, were identical, but which could operate any unit of studio equipment, be it film, tape or live camera. Unfortunately, time did not permit any study into the possibilities of using coded pulse trains and "phantom" circuits in order to reduce the inordinate number of wires and switching units required by available equipment.

## The Plan Selected

The remote control of equipment was therefore programmed as a second phase of the installation, but the assignment switching system was designed and built with sufficient flexibility to enable the inclusion of integrated remote control at a later date.

As initially planned, the assignment system will be capable of control over studio outputs, incoming and outgoing network feeds, video-tape-recording, film chains, all pulse requirements, audio and communications. It will also be flexible enough to embrace the assignment of studio camera-control units, should this prove desirable at a later stage.



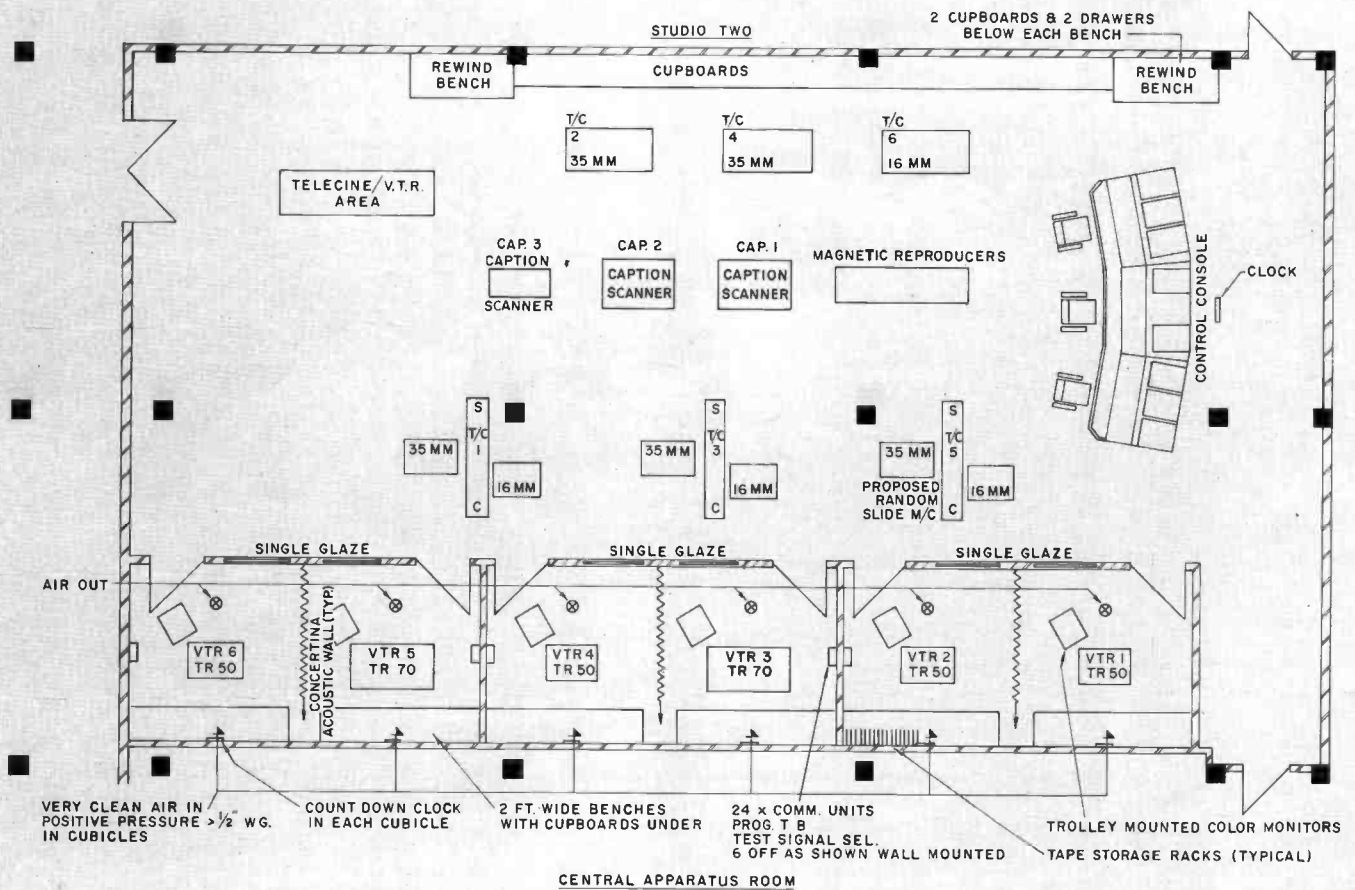

FIG. 2 The layout of the telecine/television tape area; from the control console all machines can be operated. This console also houses the assignment switcher control panel. The 3 "T/C" machines installed next to the Studio Two wall are the Flying Spot Telecine Units. On the other side of the room are the three lead-oxide film chains and in between are situated the caption scanners and the magnetic reproducers. The television tape machines, coded "VTR", are arranged in pairs. The booths are normally used as single cubicles by closing the folding doors. The folding back of these doors enables pairs of machines to be used for electronic editing sessions.

In addition to the technical gains, centralization and assignment provided other advantages. It provided the flexibility needed to meet the fluctuating demands of the production load, thus minimizing capital investment and giving more chance of meeting peak activity requirements without over-equipping.

Perhaps more important, it provides greater opportunity for the program producing staff to exercise their creative abilities.

Practically, a modern, efficient, studio center can be likened to a program factory. Sometimes producers tend to get upset about this description, but it is applied in the context that the main role of the engineer in broadcasting is to provide a system which enables the program department to concentrate on making the best possible product for the viewers consumption.

To carry this idea further, one must conclude that this description can be made fact and can best be achieved by removing from the control rooms all involvement in the mechanics of the system and by allowing the producers, camera directors, lighting men, and others of the production staff, to concentrate on

the creative function and not have to worry about "twiddling knobs".

The concentration of equipment brings with it a concentration of skilled engineers, whose function is to optimize the working of the equipment and systems, thus ensuring a standardization of performance and removing from studio control rooms the possibly incompatible subjective judgment of a technician.

To sum up, Yorkshire Television engineering philosophy is to provide the means whereby the production staff can have the greatest opportunity of using their talents, by designing a highly flexible system capable of consistently producing high quality pictures.

### Studios and Control

The studio and technical area block is constructed in three levels, ground floor, first floor and second floor.

The ground floor includes studios 2 and 3, the control room for studio 2 and wardrobe, dressing room and electrical and electronic maintenance areas. A single control room is used for studio 2, as it is felt

that immediacy of contact between operational personnel is of great assistance for the magazine, news, and other largely unrehearsed programming that will be carried out in this studio.

On the first floor is the central apparatus room (CAR), the master control and presentation control areas, studios 1 and 1A and the television film/television tape areas. A large window physically separates master controls and presentation controls, but enables continual visual contact. Also, presentation control has a direct view into the two promotion studios (1 and 1A), which are normally used for vision announcements. The patch panels in the CAR are the previously discussed camera patch panels. All equipment is housed in racks and included here are the system standards converters, which are required as the existing service is on 405 lines and is not scheduled to change to 625 lines UHF until 1969. The studio control rooms are elevated and have a view over the cyclorama into studios 2 and 3, which are two levels in height. The operators sit with their backs to the studio. A recessed viewing area in front of the production control desk enables designers, wardrobe, and other production personnel to see the picture monitors without obstructing the director's or producer's view. Viewing windows into the studios are tinted magenta and blue. This is to minimize the colour

FIG. 3 The RCA TR-50 installed in the mobile van, which was designed and equipped by RCA Great Britain Ltd.

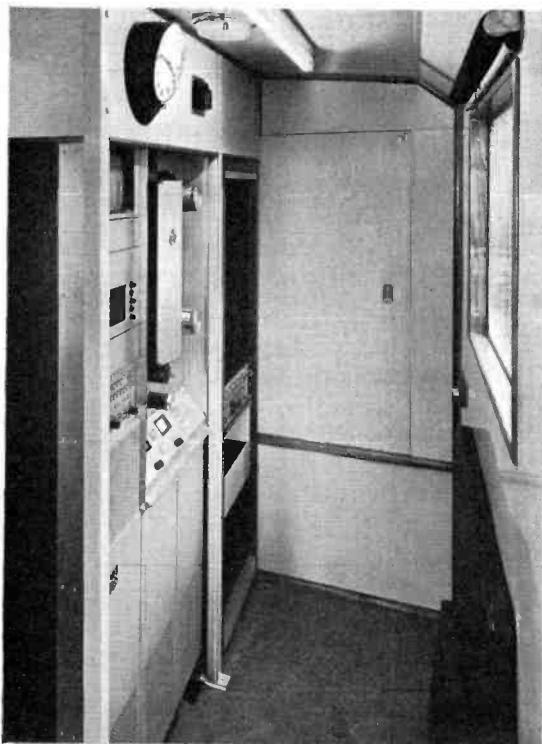

FIG. 4 The Author, P. G. Parker, Chief Engineer, Yorkshire Television Limited, examining one of the two RCA TR-70 television tape recorders.

difference between the physical appearance of the studios and the picture on the monitor.

Control of the cameras and the lighting is under the supervision of the lighting director. Camera controls in this area are aperture, black level and colour balance, although it is hoped that with more experience, techniques can be developed which will minimize the use of colour balance controls. The lighting director has control of the dimmers which are SCR's. Switching information for the lights is stored on a computer drum, which supplies all three studios. Physically, the lighting grid employs monopole lighting units which can be traversed along slots for ease of positioning. The lights can be raised and lowered by pneumatic winching and may also be transferred via a transfer track at the end of the grid to re-allocate them into slots or to transfer them from studio to studio, or to the maintenance area. This particular studio has a 24 channel sound mixer. The larger studio has 36 channels, which can be supplemented with an additional 24 channels. All studio vision mixers are identical and consist of 14 input A, B, C, D, cut-in blanking, double entry mixers, with: mix, wipe, inlay and overlay facilities. In common with the other video routing equipment, they have been designed to comply with the stringent ITA colour specifications.

The central apparatus room houses all electrical switching and distribution equipment, together with live camera, television film and all other origi-

nating electrical equipments. On the floor above is studio 4 and the control rooms for studio 3, for the film area, and the ventilation plant and the preview theaters.

### TV Tape Equipment

Obviously, it is essential that all equipment used in such a system must be absolutely reliable, stable and capable of simple remote control.

Readers of British technical journals will be aware of the substantial contracts which Yorkshire TV have placed with a number of British equipment firms. One important area, however, in which there are no entirely local products is that of the vital television tape-recorders.

In this case, the above factors, together with cost efficiency evaluation and study of the technical features, led us to choose a single firm—RCA Great Britain Limited—as the supplier of all television tape recording equipment.

Our total requirement is for seven machines at a contract price well in excess of a quarter of a million pounds. Two of the recorders will be the sophisticated RCA TR-70s for multiple editing, prestige and overseas tape operations. The remaining five will be the versatile RCA TR-50s which will carry the day-to-day work-load of the station. One of the TR-50s will be used in the mobile recording vehicle previously discussed in this article. All of the tape machines, as delivered, will be fully colour capable and are fitted with Chroma Amplitude and Velocity Error Correctors (CAVEC), together with Colour Drop-Out Compensators and, in the case of the TR-70s, Electronic Splicing.

### Other Equipment

As mentioned previously, all equipment in Yorkshire Television's studios is colour equipment. In addition, there will be two other remote vehicles, each equipped with four live colour cameras. There will be 13 colour cameras assigned to the three studios, the assignment switcher allocating as the load requires. Switching capability shall be as follows:

- a. Studio 2 which is 2,500 square feet in area will normally have two cameras permanently connected and will have capability to have another four assigned.
- b. Studio 3, which is 4,500 square feet in area, has four cameras permanently connected and can have up to five assigned.
- c. Studio 4, which is 8,000 square feet in area, will have four cameras permanently connected and can have up to six assigned.

The six tape machines in the studio are arranged in pairs as follows: 2 TR-70s, 2 TR-50s, 2 TR-50s.

There are a total of six colour film chains—three of these are lead-oxide multiplex units each consisting

of 35mm and 16mm projectors, with multi-access slide projectors. The remaining three film islands employ Flying Spot Scanners, two using 35mm projectors and the third using a 16mm projector. There are three caption scanners which have facilities for clocks, opaque captions, television tape input leader titles, and other insertion devices. These have monochrome lead-oxide cameras with "cox-box" units for transcoding the output picture into any two colour combinations. The presentation or output switcher is of unique design with a 15-store memory. There is a rehearsal mode which enables complex promotion spots to be rehearsed and recorded whilst maintaining transmission.

Pulse distribution is carried out by a coded pulse system. All drive and timing pulses required are combined and transmitted over a single coaxial circuit. This greatly simplifies the problem and cost of assigning colour pulses as all pulses may be switched to any combination of equipment by means of a single switch and one delay line which also simplifies timing. Phasing facilities are provided at the pulse decoders and encoders which also eases the critical timing required in colour operations.

The Assignment Switcher assigns picture originating sources in any desired combination. Talk-back, sound and video are all switched in this system.

FIG. 5 Looking down from the 1,265 ft. Emley Moor transmitting tower, the tallest in Europe. (Photo courtesy "British Insulated Calendars Construction Co. Ltd.")



# KOB RADIO AND TELEVISION



Pioneer Station in Albuquerque  
Sparkles with Color  
and Adds FM Stereo in  
Hubbard's Expansion Program

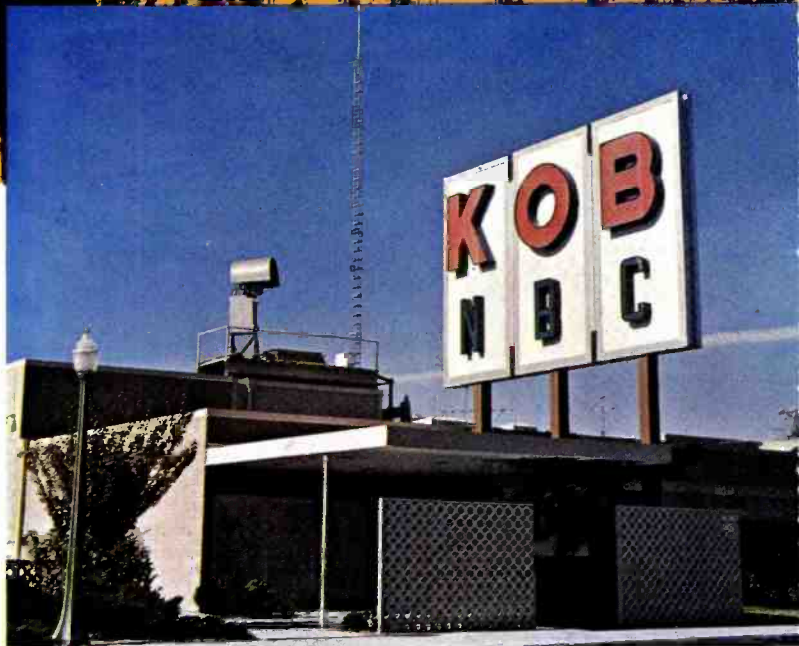

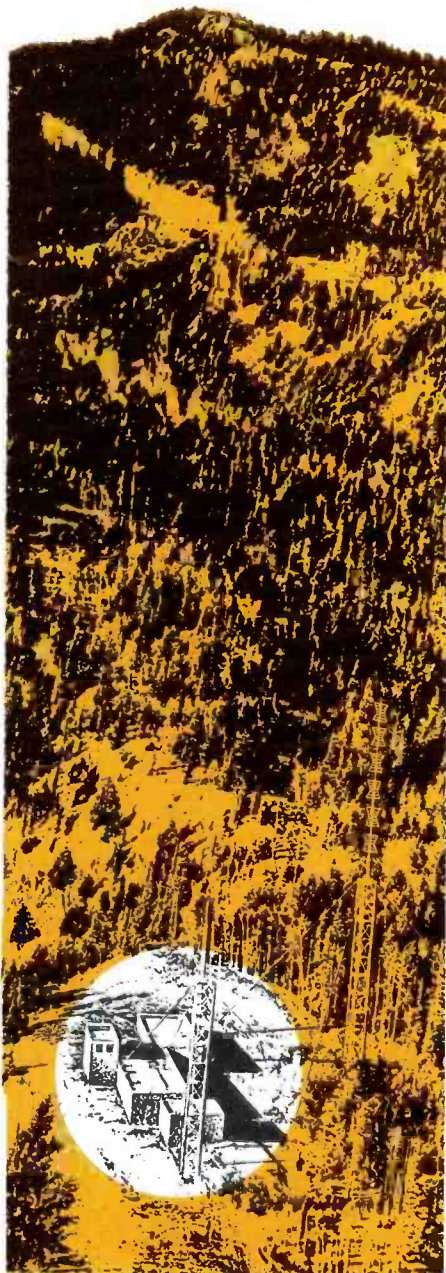

FIG. 1 Building in downtown Albuquerque houses all KOB Radio and Television studios and offices.

FIG. 2 Transmitting site is 16 miles from Albuquerque studio, atop Sandia Crest (over 11,000 ft. elevation). (Inset shows Lt. Governor E. Lee Francis and Stanley S. Hubbard at ribbon cutting ceremonies.)

## Introduction

Early in its operation, KOB-TV established a reputation for public service and fine entertainment, which has gone a long way towards making Channel 4 popular in the Albuquerque area. In 1957, the station's reputation received a boost when Hubbard Broadcasting took over. The following ten years saw considerable investment to improve facilities for bettering programming and service to clients. Expressed in the words of President Stanley S. Hubbard, "We have never lost our abiding faith in the future of the *Land of Enchantment*."

## History of KOB Television

At a time when few in the nation were willing to make the necessary financial investment, the owners

FIG. 3 Floor plan layout of station KOB AM-FM-TV.

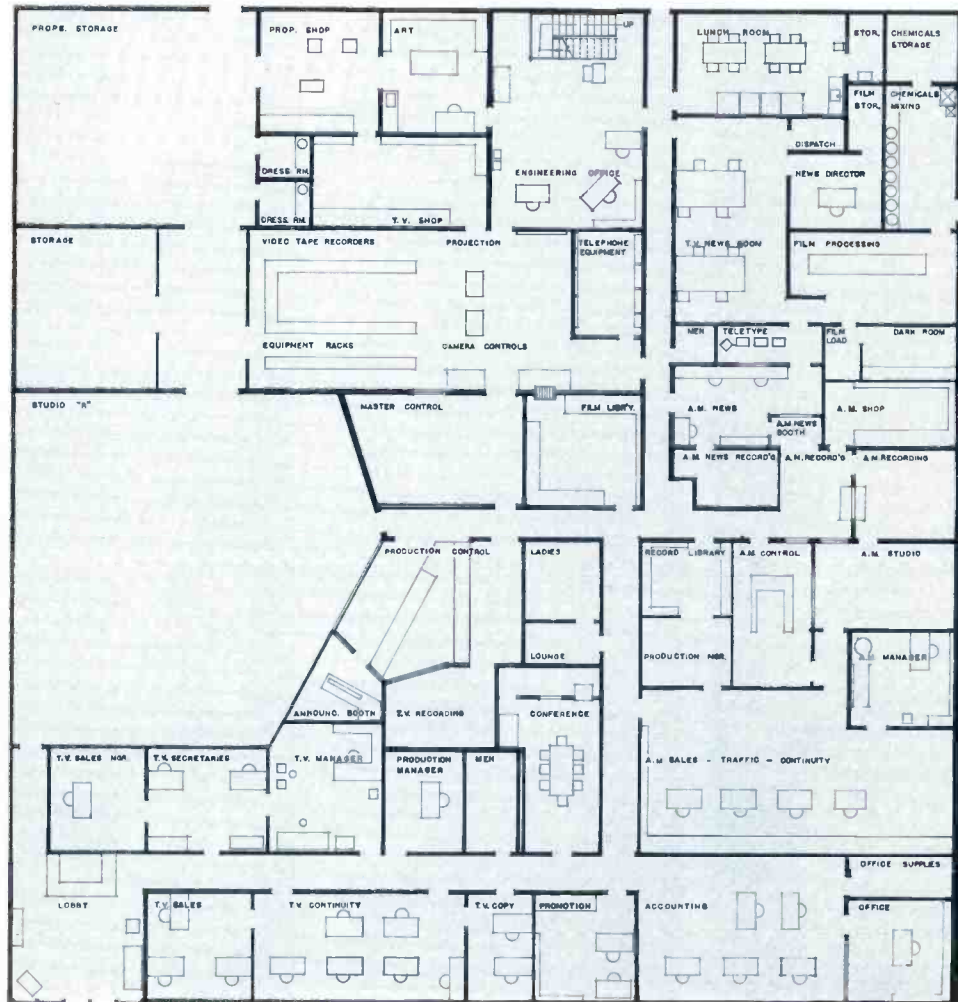

of KOB radio filed with the FCC for a permit to establish a television station in Albuquerque. That was in 1948.

The grant was received and KOB-TV telecast its first programs on September 13 of that year.

Network kinescopes brought many of the top shows to the Albuquerque market, along with local shows, special events and sports coverage, which quickly increased the size of the audience.

A further development in growth occurred in 1953 when the station installed a new modern transmitting system on Sandia Crest, doubling the coverage.

Acquisition by Hubbard brought new studio and plant facilities, completely converting the station to color, and equipping it with the finest color cameras, color lighting, tape recorders, and TV film equipment available in the nation today.

### The Hubbard Touch

Mr. Stanley E. Hubbard, founder of KSTP in Minneapolis, is somewhat of a legend in the broadcast industry, with pioneering as a steady diet, having fathered many "firsts" since the early days of radio: First to establish a complete news bureau; first to establish a special events department, equipped with mobile units; first to serve his community with a full-time educational department.

Son of the pioneer, Stanley S. Hubbard, expresses the same rugged individualism and progressive spirit of his founder father. That's the reason for the expansion at KOB, and for emphasis on modern techniques, finest equipment, and public service.

Like its sister station in Minneapolis, KOB is bringing the finest in Color TV to Albuquerque, with an outstanding news operation, color processing

equipment, art and production services, engineering and business departments.

### New Addition

The year 1967 saw the realization of an ambitious project for adding a two story addition to, and remodeling of, the KOB studio plant. The new wing added 6200 square feet in order to permit complete conversion for full color operation. This makes the KOB building the largest and most complete broadcast facility in the state.

FIG. 5 KOB-TV Color Film/Slide chain using TK-27 Color Camera, TP-15 Multiplexer, TP-7 Slide Projector, and TP-6 16mm Film Projector.



FIG. 4 Tom D. Austin, studio technician at two TR-70 tape recorders.



The addition houses a chemical mixing and analysis room for the recently acquired color processing equipment, expanded newsroom space, engineering shop quarters, art department, carpenter shop, talent dressing room, and TV audio record center.

Remodeling provides advertisers with facilities in the conference room for viewing slides, film, video tape recordings, programs in progress, or for listening to AM, FM or sound tape. Also, new productions and master TV control centers, separate from each other, so that production may proceed without interruption to on-air crews.

### New Color Equipment

The 45-by-60 foot main studio has been completely converted to color using Colortran Sky Pan and Century Incandescent lighting systems. Lighting is upped to 300-400 foot candles in order to stop down to f/11. There are seven monochrome cameras, but they are used mainly for remote telecasts. Two RCA TK-42 Color Cameras have been acquired. Fully transistorized, these "Big Tube" color cameras are the finest available today (according to station management). New sets and props have been created expressly for color telecasting. Furthermore, the new wing has been designed to include a 30-by-30 foot area for conversion into a second color studio.

The television tape area contains a total of five highband color machines. Three are conversions to highband of TRT-1 equipments. Recently two of the new RCA TR-70 Color Recorders were installed. These are switchable for either highband or lowband operation. They produce the sharpest, most brilliant, truest color pictures obtainable. KOB does 45-50 hours of delayed programming on tape weekly, in addition to local programs, announcements and commercials. A portable monochrome VTR with slow motion and stop action is available for remote use, special events, and back-up.

The film area accommodates one monochrome film island, one color film island, and space for a second

FIG. 6 Gary Kanin "News in Sight" every day except Saturday at 6 PM in color.



FIG. 7 Remote truck is fully equipped with all that is needed for color operations.



FIG. 8 Gordon Sanders gives away money and merchandise on the "Wheel of Fortune" afternoon movie.

color film island, in process of being procured. The RCA TP-66 Television Film Projectors, TP-7 Slide Projectors are employed together with TK-27 Color Film Camera. This "matched" system makes color films much like live in picture quality.

### Color News Films

The Television News Department can view, edit, and write copy for film very shortly after return of the cameraman, because KOB has its own high-speed processor. This equipment is in its own area near the chemical mixing and analysis room. A technician on the staff controls quality by frequent chemical analyses and densitometer readings. All filming is done in color, some 30,000 feet of color film is processed per month!

### Color Mobile Unit

Measuring 34 feet in length, the KOB-TV Remote van houses four monochrome or two color cameras, a portable video tape recorder, and a complete director's console. It will accommodate a full technical crew in order to handle production of commercials on location or live remote telecasts. In addition to air-conditioning for all seasons, the van carries its own generator capable of supplying all power needed for equipment operation.

### Color Programs and Commercials

All locally produced programs and commercials are in color, including both 30-minute daily news programs.



FIG. 9 Valentino De La O of the show of the same name and his sidekick comedian Mario Leyba. This is a syndicated Spanish and American production by Harvey Norviel.

FIG. 10 KOB-TV talent Robert McCoy making color commercials for a local Albuquerque business.

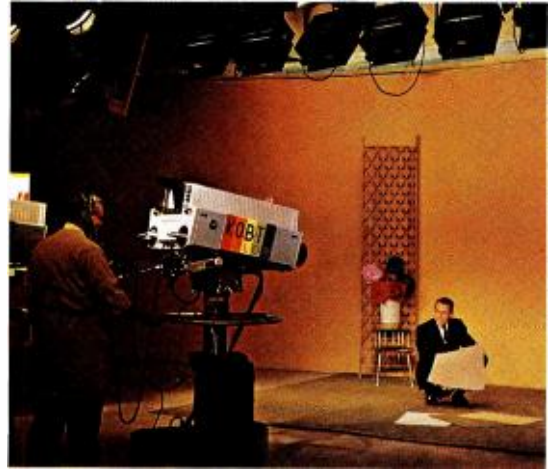

FIG. 11 KOB-TV transmitter, TT-6AL showing Fern Bibeau, chief, Operations AM-TV-FM.

Color-coordinated backdrops and props have been designed for use by advertisers, and there is a separate area for production control of tape recordings. Quite a bit of local commercial production is done by KOB; in fact, the Albuquerque Advertising Club Annual Award has been won by the station.

Locally produced shows include the following: The "Wheel of Fortune Movie" is a station film program running Monday through Friday, 2:30 to 4:30 p.m.; "6:00 O'clock News & 10:00 O'clock News"; "The Valentino De La O Show", which is a special Spanish Variety Show produced weekly by the station on tape and is also syndicated in the Western States area; "A Closer Look", seen each Sunday afternoon, is half-hour public affairs program; "Western Athletic Conference Basketball Games", live coverage of important WAC basketball games.

Special public interest programs include the "Governor's Report", a monthly program, and weekly University Programs.

### Commercials Production

KOB-TV's staff produces commercials for American Furniture Company, Montgomery Ward, Rich Ford, Local RCA Dealers Association, Piggly Wiggly Super Markets and Fred Harvey Western Division.

In addition to the fine equipment available to advertisers for commercial production, KOB-TV offers its clients two full-time staff copywriters, complete art department, photographers (both film and still), engineering crew of seventeen men and a nine-man production crew.

All KOB advertisers are eligible to utilize the







FIG. 12 AM radio transmitting building at Alameda in suburbs of Albuquerque.

station's Promotion and Merchandising Department—set up to handle direct mail, transit, outdoor, on-premise, dealer contests, sales incentive programs, in-store and market survey work and specialized promotional activities tailored to suit the individual client's campaign.

#### Antenna 11,000 Feet High

The KOB-TV transmitter and antenna are located atop 10,660-foot Sandia Crest—making it one of the highest transmitting sites in the world. From the studio in downtown Albuquerque, the signal is beamed via RCA TVM-1 Microwave, a distance of 15 miles to the Sandia Crest transmitter. A TT-6AL 6KW TV Transmitter is used together with a gain of 6. Superturnstile Antenna to radiate 27KW ERP. The TV tower is 175 feet high, making total antenna height 10,835 feet. The average terrain is 4200 feet above sea level.

The transmitter building on Sandia Crest houses both transmitting equipment (TV and FM) and living quarters for the engineers. The highest part of the building is designed to house the microwave receiving equipment. In addition, there is a second tower for the FM Antenna. Both towers are built to withstand 150 MPH winds, and stand securely with a 2-inch coating of ice.

Since the transmitter site is somewhat isolated and without water service, each shift of engineers brings with it 300 gallons of water. (There are three 6000 gallon tanks: Two for diesel fuel, one for water.) The

men work rotations of 48 hours first week, 48 hours second week, 72 hours third week, then repeat the cycle.

Emergency power diesel generators include two 100 KVA and one 50 KVA. These date back to the time when commercial power was not available, and they powered the transmitting plant for five years.

#### KOB Radio, AM and FM

Long a pioneer in AM, KOB, with the advent of Hubbard's acquisition added FM as part of its expansion effort. The new member of the KOB broadcast family has transmitter, antenna and fully-automated programming equipment atop Sandia Crest. The 50,000 Watt AM transmitter is located in Alameda—suburban neighbor to Albuquerque.

The main studios and control rooms for KOB radio are in the newly expanded downtown Albuquerque building. The main control room uses RCA cartridge tape and turntable equipment to provide quality sound reproductions. By means of a production room, with patch panel arrangement, several network or local programs may be recorded, while feeding a remote broadcast at the same time.

#### FM Stereo System

An RCA "New Look" FM Transmitter is utilized, the BTF-5E, together with the latest in FM antennas—the RCA Circularly Polarized, Type BFC, which provides complete radiating patterns for better reception by all types of receivers—portable, auto, or home.

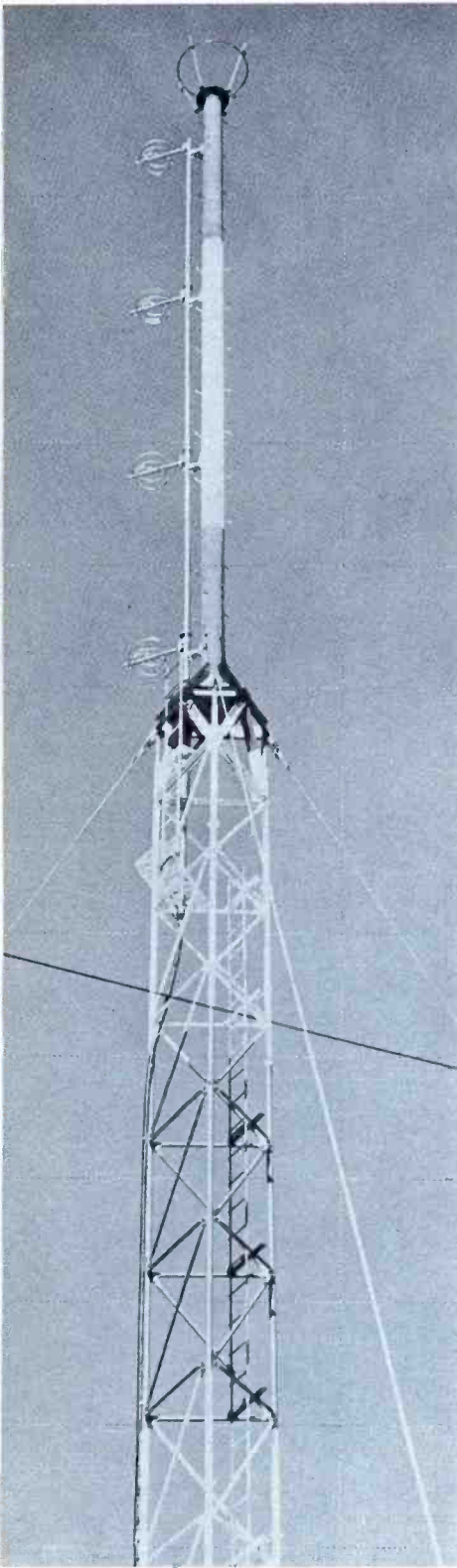

FIG. 13 Station uses RCA BFC-4C Circularly Polarized FM Antenna.

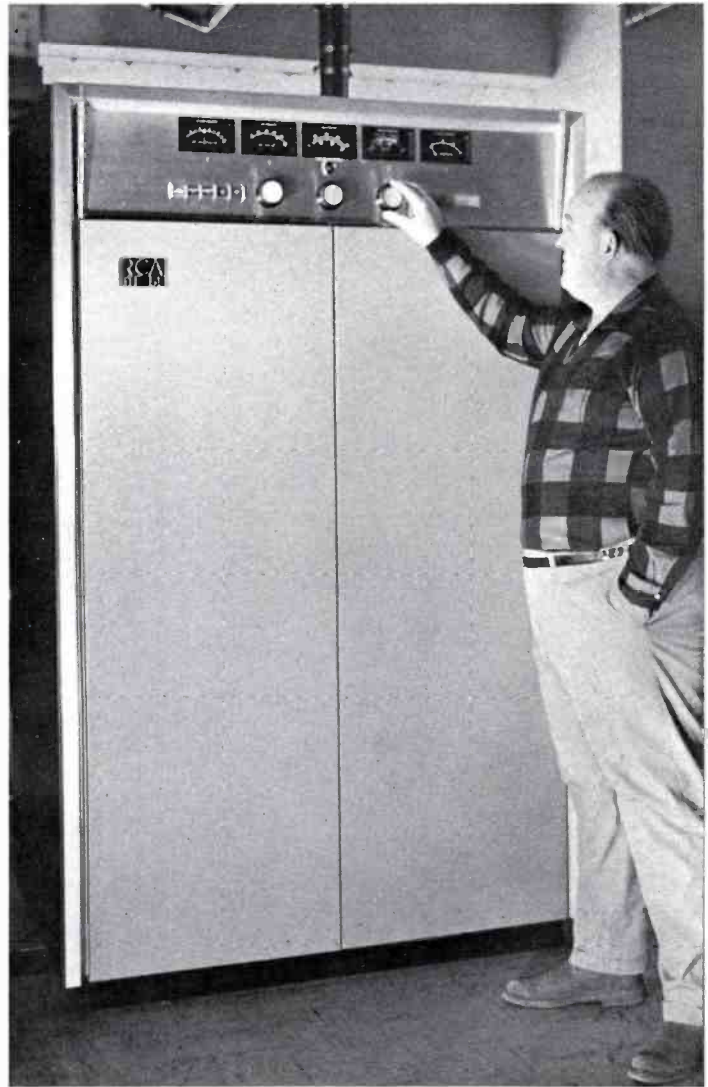

FIG. 14 KOB-FM Transmitter, Type BTF-5E, showing Ernest Courtney, TV-FM operator.

### AM Radio

Located in a Pueblo-style structure, where it has been since 1932, the 50KW Type 5C RCA transmitter is phased to a two tower antenna system. This system operates omnidirectionally during daylight, directionally at night.

Like the station, the transmitter exciter is a pioneer—a water-cooled relic of the old days that still operates 24 hours daily, 7 days per week.

The exciter is an RCA-5C, rebuilt by George Johnson—formerly Chief Engineer and Station Manager, now, Engineering Research Director—with 10KW accomplished by the re-building by addition of more water-cooled tubes and power equipment.

KOB's 50KW amplifier and modulator is an RCA 50E. One RCA Type 5671 tube in the final was installed in 1955 and is still operating with over 90,000 hours on it at this writing (March 1968).



FIG. 15 George S. Johnson, Director, Planning & Research, at RCA Type 10C (used as exciter) which is 5C modified for 10kw output.

FIG. 16 RCA 50kW air-cooled Type 50E Transmitter.



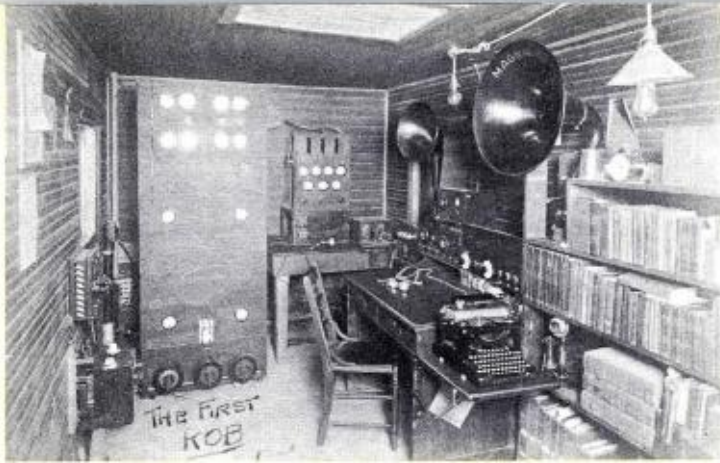

FIG. 17 In 1920, KOB was licensed under call letters 5XD and used a 50-watt CW transmitter. A commercial license was granted April 1922.

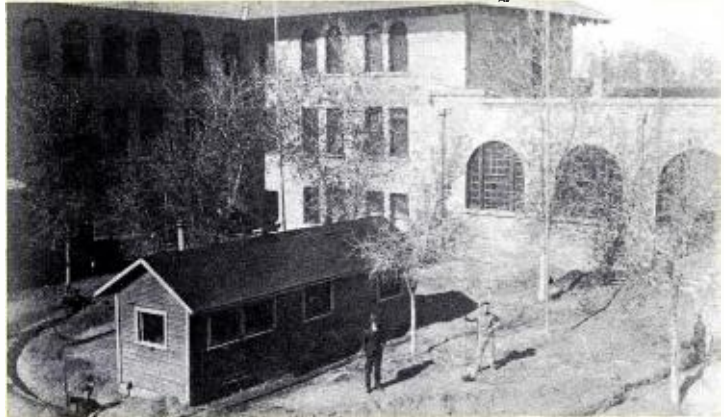

FIG. 18 The original "Cow College" station was housed in this building on the campus of the New Mexico State College in Las Cruces, sponsored by a Radio Club formed in 1919.

### Pioneer in Broadcasting

On Oct. 11, 1919, the Campus Radio Club was formed at New Mexico State College in Las Cruces for "the advancement of radio telegraphy."

A 500-Watt Marconi spark transmitter broadcast time signals and weather reports. Construction of a 50-Watt CW transmitter began in 1920 and was licensed under the call letters 5XD.

The commercial license was granted to KOB April, 1922. Arrangements were made with a Phonograph Company to supply latest hits in recorded music, and with local newspapers to furnish press releases, and a 500-Watt CW transmitter was put into operation by December.

By 1926, the "Cow College" station had its own paid studio orchestra. In 1927, the foundation was laid for a new radio house to provide room for new motor-generators. Also in the same year the Federal Radio Commission was established and KOB received a temporary permit for 5000 Watts of power—but immediately re-applied for 10,000 Watts.

KOB was the sixth largest of 685 licensed stations in 1927.

KOB was considered by the college to be a personal hobby and no allocation of funds was made, however, space was furnished and utilities paid. In 1929, with a seven man staff, several local merchants expressed an interest in advertising over KOB at rates which would sustain operating costs. The college decided to

keep the station and sell advertising time.

In April 1932, the station was transferred to Albuquerque, to more adequately serve the whole state from a centrally located city, to be managed by the *Albuquerque Journal*, but owned by the New Mexico State College. This arrangement continued until 1936 when the college sold the station to the Albuquerque Broadcasting Company, and in 1937 the station joined the NBC network.

Incidentally, KOB also brought the first television to the area in 1948.

### Future Success

For a number of years, KOB-TV was the only television station between St. Louis and the West Coast. In November, 1948, they began telecasting network programs.

Growth of KOB has been matched by the area it serves. Albuquerque itself sets the pace as one of the most dynamic metropolitan centers in the nation.

The change in ownership in 1957 augurs well for the station and the community it serves. Public service has been the keynote of both KOB and Hubbard Broadcasting.

Their long record of service, together with dedicated personnel, the finest of facilities, modern color equipment, places the station in position to provide even better performance for its clients and viewers today and in the days to come.

FIG. 1 Polygon Antenna with fiberglass radome surrounding the entire antenna, protecting it from the effects of weather, and giving it a clean attractive cylindrical appearance. Cut-away reveals unique belt-line feed system which distributes power to the five panels. The fiberglass pole steps are extremely rugged and designed for sure and safe footing.

# POLYGON 5-MEGAWATT UHF ANTENNA

New Antenna System, With Gain  
of 60, Achieves Maximum Directional  
or Omnidirectional Power

H. H. WESTCOTT  
Antenna Product Specialist

The Polygon Antenna, with the highest gain of any of RCA's line of UHF Broadcast Antennas, provides for the first time the means of attaining five million watts of Effective Radiated Power omni-directionally, even when mounted on towers up to 1500 feet in height. In addition polygon antennas may be directionalized or used in stacked arrays to support other antennas.

With new concepts in feed system, excellent vertical and horizontal patterns, and a design engineered for reliability the Polygon deserves careful consideration by the UHF broadcaster seeking maximum allowable coverage or the answer to unusual requirements.

## Design Objectives

In the development stages, the engineers at RCA's Antenna Engineering Center, near Gibbsboro, N. J., aimed at three primary objectives. These were: (1) an RMS gain of 60—necessary to obtain the required 5 megawatt ERP with the new 110 KW transmitter and practical transmission line sizes; (2) good horizontal pattern circularity; and (3) a smooth vertical pattern with a minimum calculated field of approximately 100 millivolts.

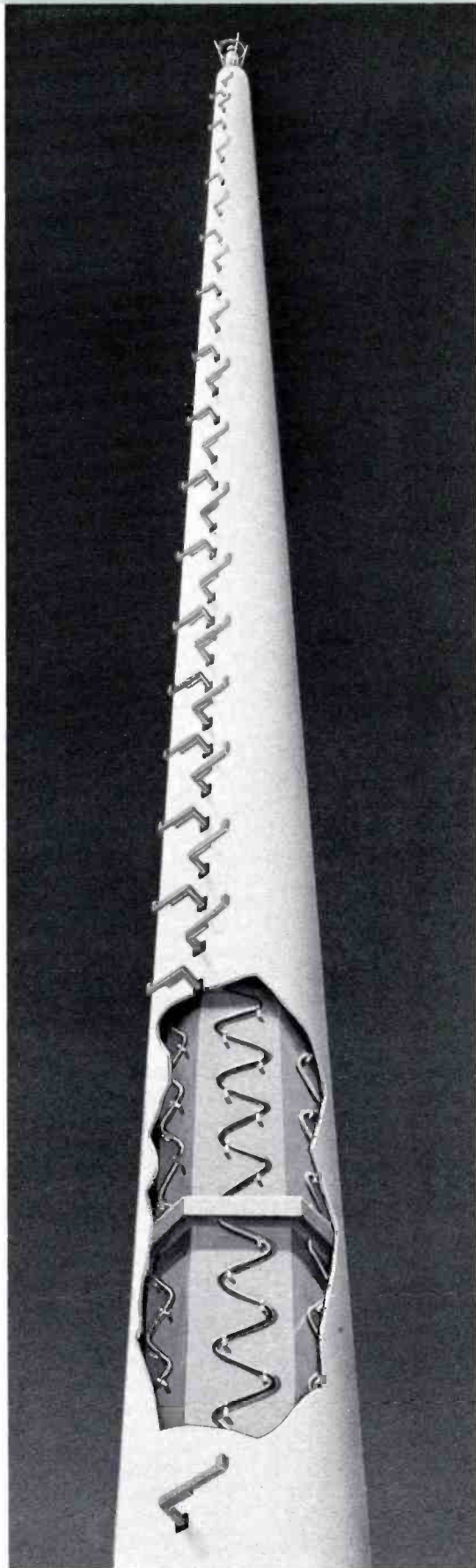

After a year and a half of development work the new Polygon was announced in January of 1968. The antenna not only fulfilled all of the initial concepts but contained within its design, flexibility and capabilities which had not originally been anticipated. The matching of the Polygon with the TTU-110A Transmitter and 8-3/16 or 9-3/16 coaxial transmission line produced RCA's precedent-setting "Omni-Max" package, unveiled to the industry at the NAB Convention in March. With this combination the

UHF broadcaster could now obtain the maximum ERP allowable and provide maximum protection for his investment.

### General Design

The antenna consists basically of RCA's Zee-type panel radiators, developed at the Princeton Laboratories in 1952, refined through the years, and proven in the field. The panels are stacked vertically in eleven layers, each layer consisting of five panels arranged in the form of a pentagon.

Simple power division within the feed system supplies equal power to each radiator around the layers for omni-directional use or unequal power for directional requirements. The internal feed system feeding the successive layers is designed for sectionallizing, making possible emergency operation of either half of the antenna through its two 6 1/8 transmission line inputs. A cylindrical radome covering the entire antenna protects it from the weather, minimizes wind-load, and provides the functionally attractive appearance shown in Figure 1.

### Power Handling

The 5 megawatt capability of the antenna is primarily made possible by its gain of 60 and its superior 110 kW power handling capacity. The relationship be-

LINE LENGTH: 1200'

Trans. Line Size	Chs.	Eff.	Trans. Power Req'd.
8 1/4 (Coax)	14-47	80.3-77	104-108
9 3/4 (Coax)	14-40	82-80.5	102-104
BWG 1500 (Waveguide)	16-60	76.5-84	109- 99
BWG 1400 (Waveguide)	25-70	75.9-82.5	110-101

LINE LENGTH: 1600'

Trans. Line Size	Chs.	Eff.	Trans. Power Req'd.
8 1/4 (Coax)	(Efficiency too low to be usable)		
9 3/4 (Coax)	14-33	77.8-75.6	108-110
BWG 1500 (Waveguide)	29-60	75.6-79.5	110-105
BWG 1400 (Waveguide)	48-70	75.6-77.4	110-108

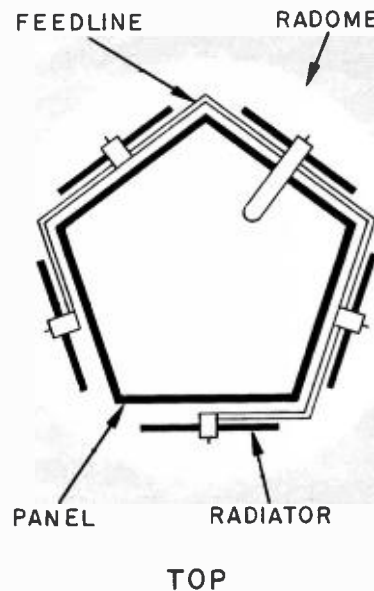
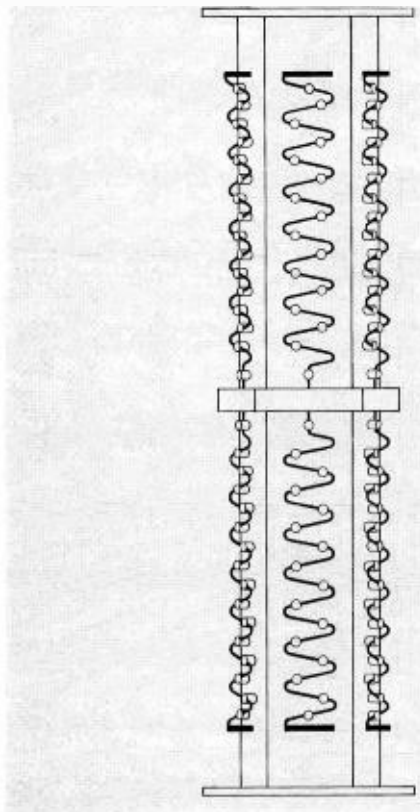

FIG. 2 The Polygon Antenna is made up of five Zee Panels welded together, forming a self supporting pentagonal structure. The signal is fed at the center of each panel and travels along the zig-zag radiators toward each end. The small amount of energy reaching the ends is radiated by the "end loading".

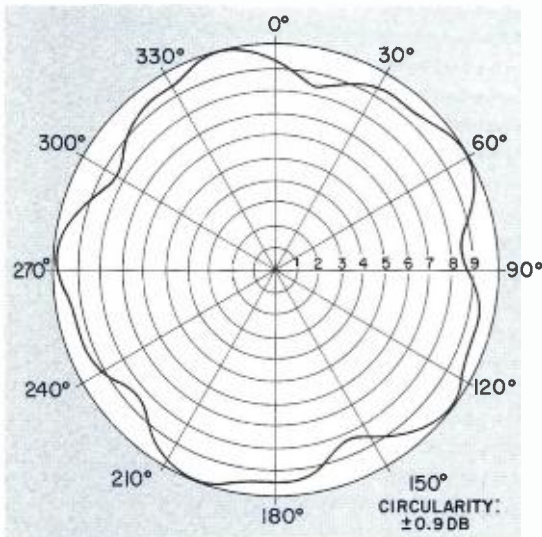

FIG. 3 Typical horizontal omnidirectional radiation pattern of the Polygon Antenna shows excellent circularity.

tween transmitter power, transmission line loss and antenna gain is shown in the table for various types of transmission line and several tower heights. The excellent combinations possible with the TTU-110A transmitter, the Polygon and appropriate transmission line is shown in the table.

### Construction

Figure 2 shows the pentagonal shape of the Polygon, formed by welding together the reflecting plates at the edges of the panels. With this design, the plates not only perform their necessary electrical function, but produce a rugged self-supporting structure which eliminates the need for the conventional internal tower. This unique construction provides maximum room for the transmission line within the antenna—an important feature in eliminating the pattern effects and added windloading inherent in external lines.

For convenient shipping, handling and assembly, the antenna may be divided into sections. Each section includes a simple flange for interconnection.

The same construction, with its great strength and building block arrangement, lends itself admirably to providing, at lower gains, the mechanical capability of supporting other antennas in stacked arrays.

### Radiating Elements

As in RCA's Zee Panel design, the signal, fed at the center of the individual radiators travels along zee-shaped dipole-length elements toward each end. The same unique principle of tapering the illumination exponentially that is used in the RCA Traveling Wave Antenna is applied here. Continuous compensation along the elements insures wide bandwidth and impedance stability. This, coupled with radiation of the

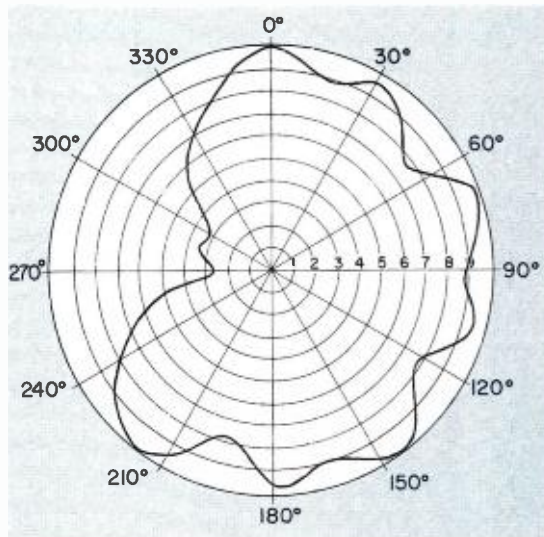

FIG. 4 Typical horizontal directional radiation pattern of the Polygon Antenna obtained by feeding unequal amounts of power to the various radiating elements.

last remaining portion of energy from "end-loading" elements, provides inherently low VSWR response across the channel.

### Feed System

The feed system design is particularly unique. Each layer (consisting of five radiators) is fed from a single feed point or line output in the internal system. Encircling the layer on the outside, and integral with its surface is a "belt-line" feed, which distributes the power to the five radiators.

When equal power is fed to each of the radiators, an omnidirectional pattern is achieved. By changing the transformers between the feedpoints to provide

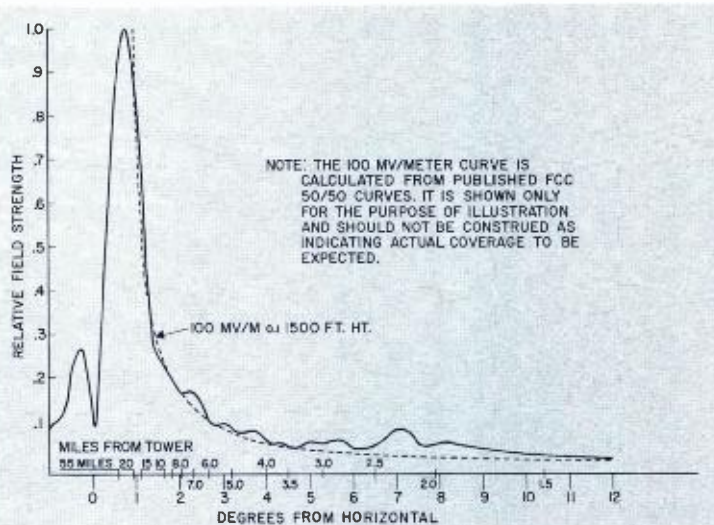

FIG. 5 Typical vertical pattern of the Polygon Antenna. The full strong signal radiated below the main beam, down to areas close to the transmitting site, is a feature of the Polygon.

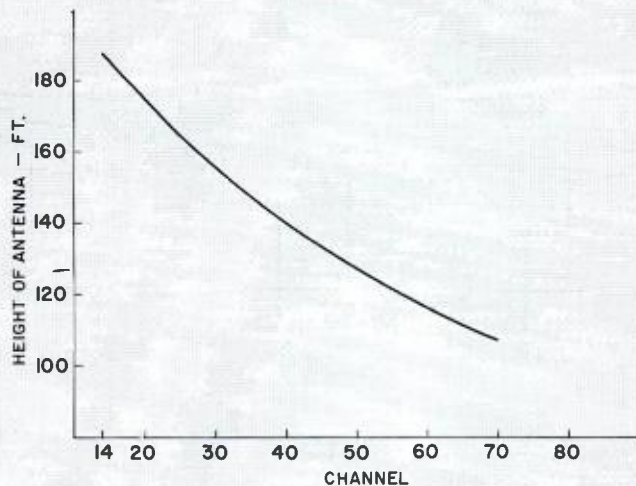
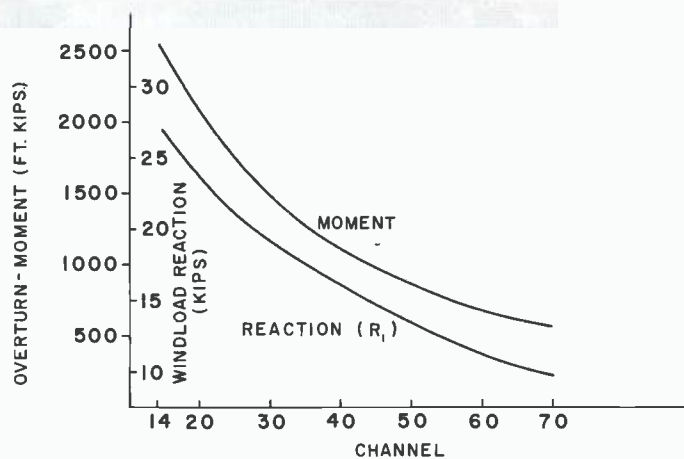

FIG. 6 Height of the Polygon Antenna for any UHF Channel can be derived from the graph. The Polygon's rugged construction insures a minimum of sway.

FIG. 7 Windload and Overturn values for UHF Channels are indicated in the graph. All Polygon Antenna elements are designed to withstand wind velocities of 115 mph.



unequal amounts of power to each radiator, a variety of directional patterns may be obtained. With a given transmitter, directionalizing permits use of a shorter antenna, and a broader vertical pattern, while maintaining the original ERP in the favored directions.

The feed system is a self-contained unit attached to the outer shell. Convenient access openings in the steel shell facilitate connection of the feed system to the "belt line" at each level.

#### Horizontal Pattern

The horizontal radiation pattern of the Polygon Antenna has excellent circularity. Figure 3 shows a typical (measured) pattern, with a plus or minus 0.9 dB variation from circular. Better than plus or minus 1.5 dB is obtainable on any UHF channel. This omnidirectional pattern can be changed to provide a wide variety of directional patterns by feeding unequal amounts of power to the elements. A typical directional pattern is shown in Figure 4.

#### Vertical Pattern

The vertical pattern is particularly important in an-

tennas of high gain since the large amount of power needed for the main beam must not be allowed to penalize the close-in coverage to an undesirable extent. The typical pattern in Figure 5 is attained by optimum balance of power division and relative phasing along the aperture. The smoothness of the Polygon pattern is such that even from a 1500 foot height, the indicated field strength is approximately 100 millivolts per meter all the way down to 12 degrees below the horizontal, very close to the tower itself. The full, strong signal radiated below the main beam, is a special feature of the Polygon. Beam tilt where desired is readily obtainable.

#### Dimensional Characteristics

The length of the Polygon Antenna ranges from 110 to 185 feet, varying, as does the diameter, with frequency. Its rugged construction insures a minimum of sway. Values for the length, including the 3-foot high lightning protector, are given in Figure 6. In stacked arrays where a Polygon with a lower gain is used, the length is proportionally shorter.



## Windloading

The antenna is designed to withstand wind velocities of 115 mph (55 lbs./sq. ft. on flat surfaces, 37 lbs./sq. ft. on round surfaces). Windload and overturn figures for the various channels are provided in graphical form in Figure 7.

## Weather Protection

Protection against the effects of weather and climbing damage is provided by a smooth and attractive fiberglass radome completely surrounding the antenna, eliminating the need for heaters. The radome can be removed in easily handled sections.

All hardware is of corrosion resistant material, either stainless steel, non-ferrous alloy or galvanized steel.

## Servicing

Access to the antenna and to the beacon is by fiberglass pole steps of the type proven so effective on the Traveling Wave and Zee Panel Antennas. The steps are extremely rugged and designed for sure and safe footing. Appropriately placed supports for "bosun

chair" rigging are provided to facilitate painting and servicing.

## Transmission Line

The values shown in the graphs in Figures 8 and 9 provide the information necessary to determine the type of transmission line and the length required to attain 5 megawatts ERP.

## Conclusion

In summary, the Polygon features are: excellent vertical and horizontal radiation patterns, rugged shell construction, a unique feed system, traveling wave feed with endloading for VSWR stability, radome protection eliminating electrical deicing, and grounded radiators for additional lightning protection. The Polygon Antenna provides maximum allowable omnidirectional ERP for UHF. It is also adaptable to directional pattern, and stacking requirements. In all versions its smooth, null free vertical patterns insures excellent coverage throughout the service area. With these characteristics the Polygon Antenna fills an important need in UHF-TV, and is a significant step forward in broadcast antenna design.

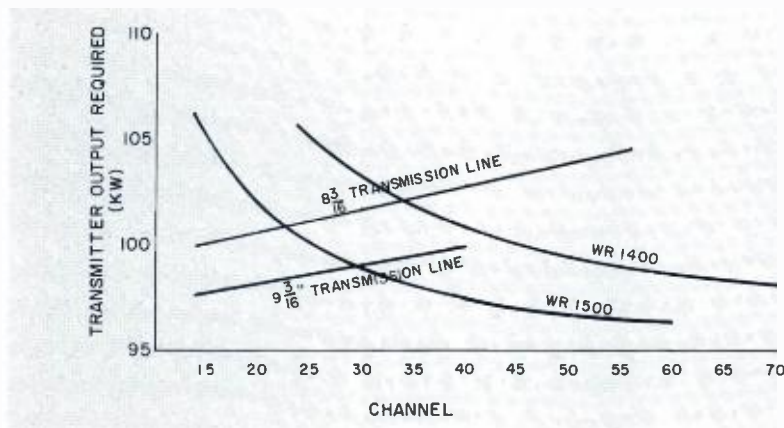
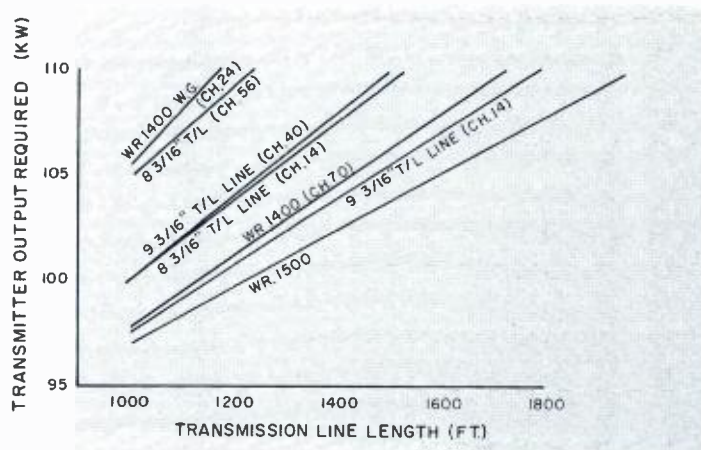

FIG. 8 The graph shows the type of transmission line required for a specific transmitter output to attain 5 megawatts ERP on any UHF Channel.

FIG. 9 The transmitter output versus transmission line length values required to attain 5 megawatts ERP are provided in the graph.





# The Best of Both

New TK-44A, "Best of the 3-tube  
Camera World" Shares Color  
Demonstration Studio with the TK-42,  
"Best of the 4-tube Camera World"

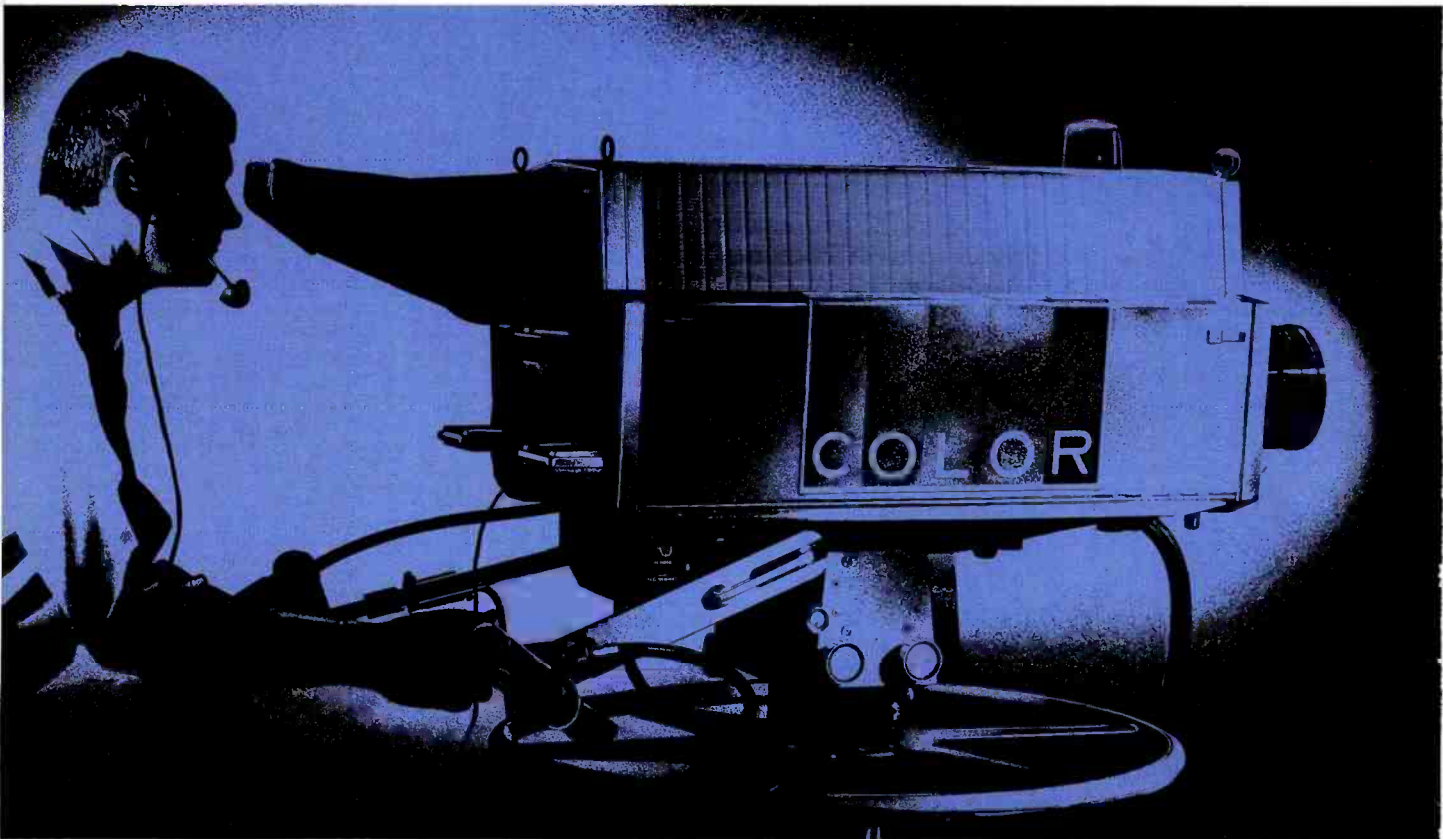

# Worlds at NAB

Two types of color TV cameras—each representing a different “world” of design philosophy—shared the spotlight at this year’s NAB Convention. First the TK-42, a 4-tube design employing a 4½-inch image orthicon in the luminance channel for sharpest color pictures. Second the TK-44A, a 3-tube design employing lead oxide tubes and contour enhancement circuits. Both cameras represent the best available in both the 4-tube and 3-tube worlds—the TK-42 with its high degree of technical sophistication and its reputation for producing the very finest of color pictures—and the TK-44A with its compact, lightweight design and a host of the very latest operational features.

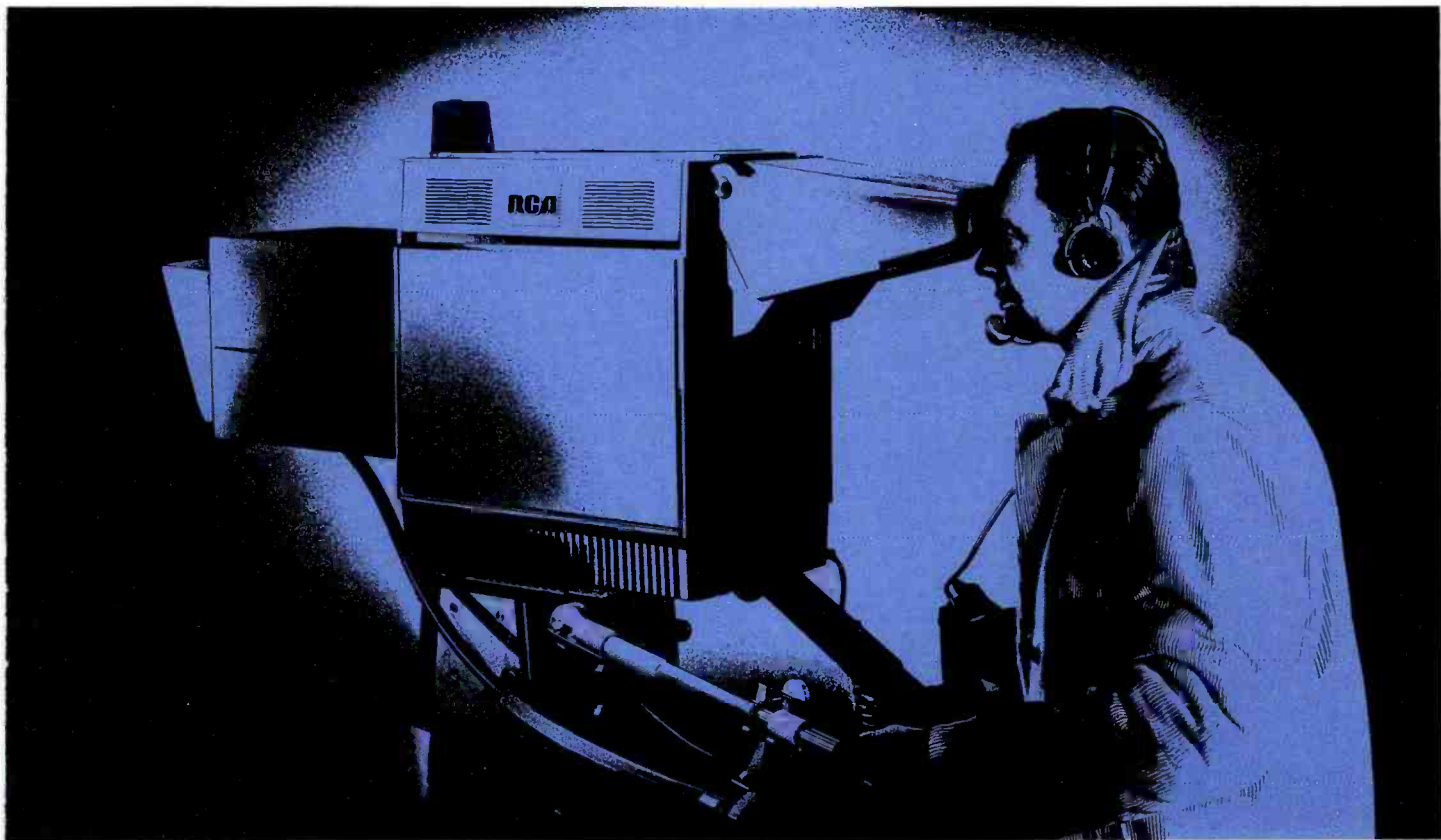
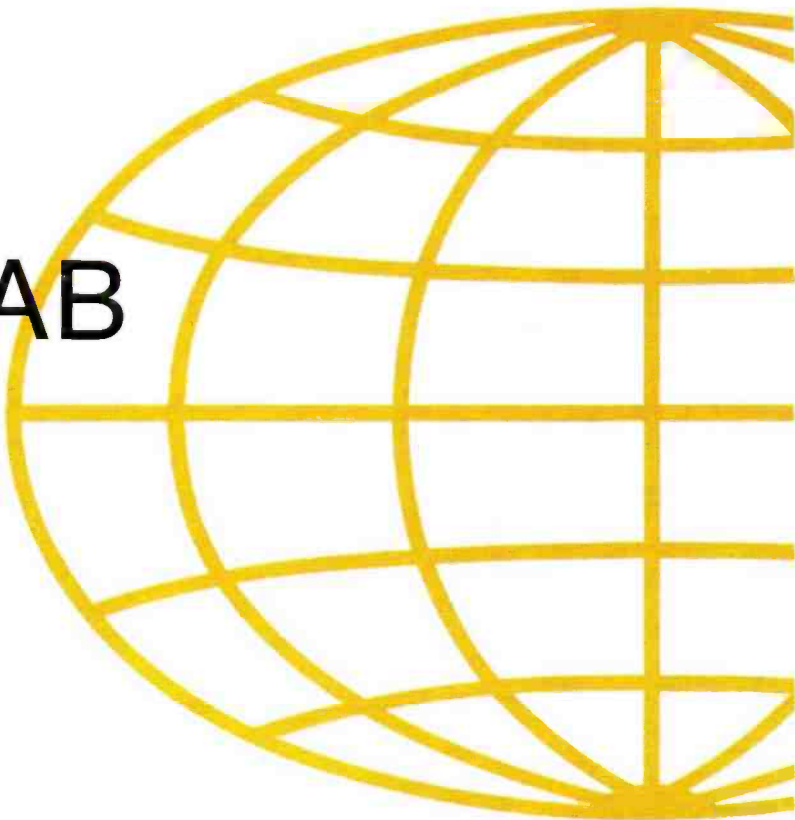



ACCENT ON TECHNICAL SOPHISTICATION as the model at left shows the modular design of the TK-42. Below she points out the fourth tube . . . a big 4½-inch image orthicon for highest definition and sharpest color pictures.

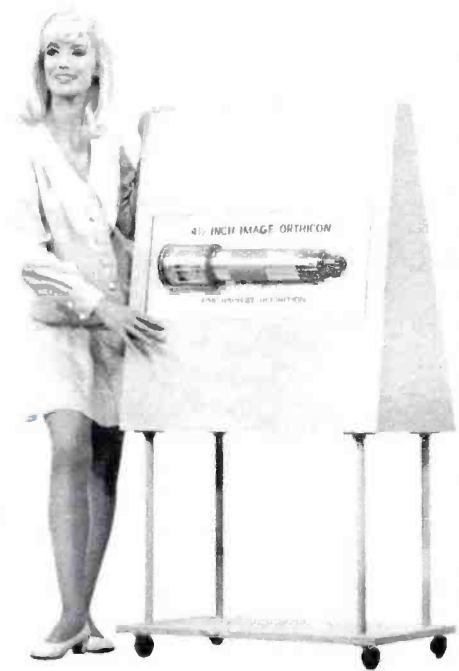

### Presentations Show-Off TK-42 and TK-44A Camera Features



EQUIPPED TO TRAVEL the new TK-44A uses three lead oxide tubes, see above. It's compact, lightweight design is demonstrated at right as model shows how easy it is to remove the self-contained zoom lens system from the camera head.





CYC AND SCRIM enclosed the color demonstration studio. Striplights, overhead and floor, used new plastic gels, in the primary colors, to produce a wide variety of color backgrounds. Quartz fixtures, supplied by Colortran, were used throughout the studio. The basic simplicity of the set demonstrated the kind of sophistication color lighting can bring to color TV pictures.

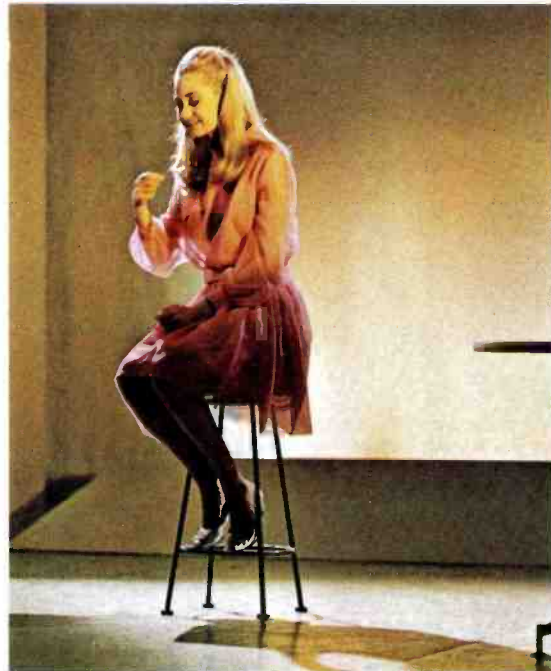

LIGHTING FOR MOOD was the subject of a short pantomime which pictures a day in the life of a busy working girl—from the first crack of dawn, through a hectic day at the office, an evening on the town, and so to bed. This was technically achieved through a wide use of lighting techniques—pattern projection, color gels and color-changing background. The resulting pictures showed how well both TK-42 and TK-44A cameras are equipped to handle these imaginative new production techniques.

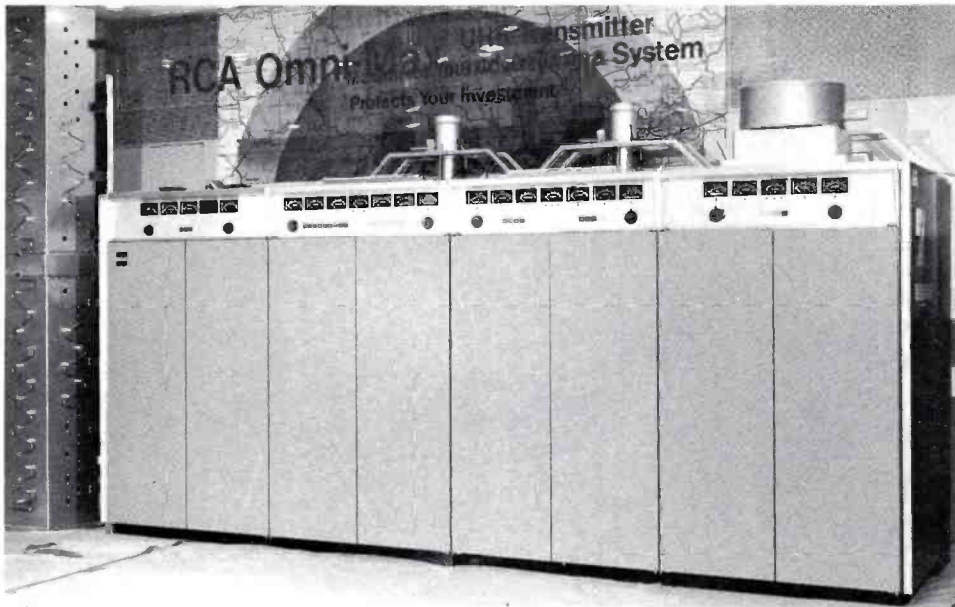

MAXIMUM UHF COVERAGE is provided by this Transmitter-Antenna combination. Dubbed the RCA Omni-Max System, it consists of the TTU-110 Transmitter and the Polygon Antenna. The system provides the maximum allowable UHF coverage of 5 megawatts ERP omnidirectional or directional, affording protection for a UHF station's investment by covering the outlying areas before somebody else does.

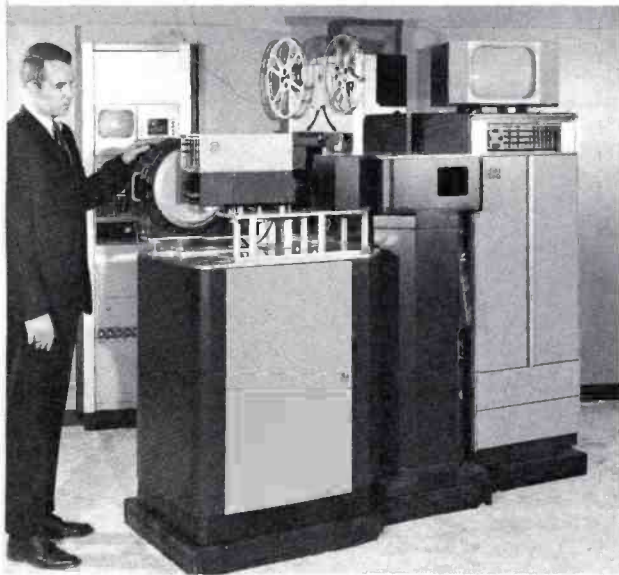

"ALREADY DELIVERED, 560" proclaims the sign over this color film system display. The TK-27 color film system has earned this leadership through technical innovation. With more automatic operating features than any other color film system, it is the first choice of value conscious broadcasters.

MAXIMUM ON-AIR INSURANCE FOR VHF is now available by using two identical VHF television transmitters combined in a parallel system. It is the subject of keen interest in the photo below as the operation of the central combining rack is explained. Parallel transmitters achieve maximum reliability by virtually eliminating off-air time while providing improved performance over single transmitter systems.





NEW TAPE EDITING SYSTEM was a highlight of the TV tape equipment display. Called a Tape Editing Programmer this new equipment preprograms electronic splicing functions and allows the editor to preview the splice and splice points before actual editing begins. In the photo left the compact unit is mounted in a console to provide remote editing of highband TR-70 in the background.

NEW SOLID-STATE RADIO EQUIPMENT that carried out the "What's New in Radio" theme were the new RCA AM/FM Audio Automation System using solid-state logic and relay switching, a new solid-state FM Exciter, Stereo Generator, SCA Generator and new wideband solid-state FM Monitors. The broadcasters showed a tremendous amount of interest in this area throughout the show.



LIVE RADIO STUDIO was operated by Miss Dolly Holliday, who is hostess of "The Nighttime Show" on radio, sponsored on 60 radio stations in 50 markets by Holiday Inns. The turntables and cartridge tape equipment were built into new modern studio furniture offering custom design at reasonable cost. Dolly had plenty of time to meet the broadcasters since she could operate completely automated by punching up the new RCA Automation System through the console.





FIG. 1 Lightweight and compact, the PK-330 Studio Camera produces crisp, high-resolution pictures. The camera has built-in pan and tilt functions and a motorized zoom lens.

# PROFESSIONAL TELEVISION PROVIDES ANOTHER CHOICE

A Complete Line of RCA Television Equipment Offering Simplicity of Operation, Performance and Economy.

There's a new class of equipment showing up in television studios around the world. It's called RCA Professional Television. It's specifically designed to offer broadcasters and other users of television a simplified system of quality equipment. Both broadcast stations and closed circuit users have been employing the equipment over the past several years.

Before the Professional Television line was introduced, only two basic types of equipment were available—deluxe broadcast equipment and low-priced "industrial" equipment. For some applications, the former was too sophisticated while the latter was marginal in performance. Professional Television is a high quality line that is engineered to suit a wide variety of needs, yet priced in the "middle" range.

During the three years since shipment of the first Professional Television product, a complete line of cameras, switchers, film systems, consoles, display equipment and other units has been developed. Every item is designed to meet the needs of TV users who desire broadcast-type picture clarity, reliability, and stability in addition to economy and simplicity of

GORDON W. BRICKER  
Manager, RCA West Coast Operations





operation. Special attention is paid to the needs of independent and educational broadcasters, both in the United States and other countries, and to instructional television requirements, where government support is making it increasingly possible for schools to own quality-built TV systems.

### Implementing Design Objectives

To meet the objectives shown above, every product in the Professional Television line is designed to include the following advantages:

- Many features normally found only on deluxe broadcast equipment, such as true gamma and aperture correction, are included.
- All equipment is designed for use in a system, being matched in electrical and mechanical performance as well as in color and appearance.
- Solid-state circuitry is used almost exclusively for extended operating life, added stability, and increased reliability.
- Modular packaging is employed to provide maximum flexibility, to protect against obsolescence, and to facilitate system expansion.
- All switching and terminal equipment is capable of handling *color* signals without degradation, permitting customers to convert to color by adding only cameras, monitors and accessories.
- Remote control panels are provided for major equipment items, permitting the system to be controlled from a console with a minimum of skilled technical personnel. Like the other products in the line, the panels are matched in appearance, styling and configuration.

### Broadcast vs Professional Television

For many key applications, major broadcasters demand—and get—equipment which assures the ultimate in performance and reliability. Controls are provided on deluxe broadcast equipment for adjustment of a wide variety of operating parameters, and many functions are automated for unvarying quality. While costly, these features are essential for broadcasters who must depend on unexcelled pictures and uninterrupted signals for their revenue. Economy is achieved in the Professional Television line by simplifying the design, not by lowering performance and reliability standards.

### Professional Television Cameras

A leading television magazine has called the PK-330 "The Aristocrat of Today's Vidicon Cameras". Customers seem to agree with this evaluation, because orders are being placed at an ever-increasing rate.

Small and light (it weighs only 50 lbs.), the PK-330 may be used with equal ease in the studio or on re-

notes. Pan and tilt functions are built into the camera, so that the need for bulky cradle heads and heavy-duty pedestals is eliminated. To tilt the camera, the operator simply moves a handle which tilts the lens—up or down. The camera and viewfinder always stay at the cameraman's eye level, regardless of the position of the lens.

The PK-330 employs phaseless aperture correction, selectable gamma correction, dynamic automatic target control, and a Type 8507 pickup tube with separate field mesh for superior picture clarity. A motorized zoom lens is built into the camera, providing smooth transitions from wide angle shots to extreme close-ups while "on the air".

Another Professional TV Camera, the PK-301, is perhaps the most popular camera ever built in its price range. Many are in daily use in applications where viewfinder cameras are not required. For instance, a number of broadcasters are using the PK-301 in news studios with remote-control pan and tilt units and zoom lenses. All controls are mounted in the console, permitting the video operator to "double" as cameraman.

The PK-301 is available in 13 different configurations, including a variety of drive options. It is also available as the PK-302, a two-unit camera with the processor circuits housed in a separate case. Drive options may be changed simply by exchanging a few plug-in circuit modules. Further, the PK-301 may be converted to a PK-310 film camera or PK-315 viewfinder camera, permitting customers to keep pace with changing requirements—without obsoleting their initial investment.

Another viewfinder camera in the Professional Television line is the PK-315, one of the PK-301 series of cameras. Modular in construction, the camera includes three separate units—camera head, processor, and viewfinder—in a distinctive package with low-profile styling.

For film use, there's the PK-310, another member of the PK-301 family. Compact and lightweight, the camera measures only 6¼ by 5⅞ by 10¼ inches and weighs just 17 pounds. It incorporates deflection and polarity reversal switches and an output for an automatic light control, in addition to features of the basic PK-301 camera.

The newest camera in the Professional Television line is the PK-501, a low-cost surveillance camera. Despite its modest price tag, the PK-501 includes such features as an automatic target circuit, keyed clamp circuit, high voltage and focus current regulation, and automatic vidicon protection.

One of the PK-501's most unique features is that it operates outdoors in any weather—rain, snow, or direct sunlight—without a costly special housing. Only a simple accessory kit is needed, and the result is a smaller package which is easier to conceal for surveillance uses.

## Camera Accessories

To complement the camera line, there is a complete selection of accessories, including lenses, mounting equipment, housings, and remote control panels.

Lenses include a wide variety of fixed focal length, manual zoom, and motorized zoom types. There is mounting equipment for virtually every application—pedestals, tripods, dollies, wall and ceiling mounts, and remote-control pan and tilt units. Housings are available for special applications.

Remote control panels are available for all cameras and other major equipment items. Designed for console mounting, the panels fit in an adaptor  $3\frac{1}{2}$  inches high and 19 inches wide. The PK-301, PK-302, PK-315 and PK-501 panels each occupy one-fourth the width of the adaptor; the PK-310 and PK-330 panels occupy one-half. Also available for the PK-330 is a remote control panel built in the RCA "New Look" format.

## Film Systems

Professional Television film systems consisting of cameras, multiplexers and projectors are being used

as primary film chains, standby units, and as backup units at the transmitter. The latter application permits programming to be originated from the transmitter if the signal connection with the studio is broken. With a low-cost sync generator, such as the Professional Television PSG-2, this compact and inexpensive combination virtually assures uninterrupted programming (except in cases of transmitter failure).

The PFS-16 is a self-contained television film system with a sturdy tabletop multiplexer offering facilities for showing slides and 16mm film. Included in the unit are a sealed optical system, control panel, PK-310 film camera, and a PFP-1600 projector. The projector is the popular RCA 1600, converted for use in TV film systems. An accessory base plate accommodates a Kodak "Carousel" slide projector.

Studios requiring high-performance, yet low-cost, equipment for showing a large number of slides have found the PTV Slide Uniplex System an especially useful tool. The system accommodates a PK-301 camera and a "Carousel" slide projector in little more than two square feet of space.

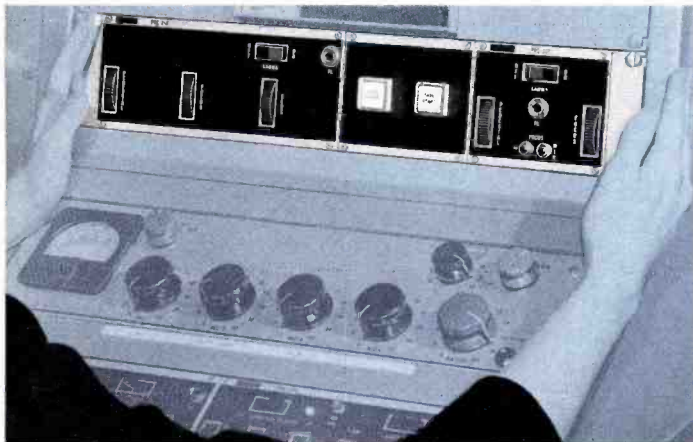

FIG. 2 Remote control panels are available for all cameras and other major products in the Professional Television line. The panels are designed for rack mounting and occupy either one-quarter or one-half of a standard 19" rack adaptor.



FIG. 3 Solid-state, modular construction permits changing the PK-301 camera to any of thirteen different configurations. It may also be converted to a PK-310 film camera or PK-315 viewfinder camera.

### TV Film Recorder

The PFR-10 Television Film Recorder is designed for monochrome installations where multiple copies or repeated playbacks of a single copy of a television recording are required. Compact and self-contained, it records EIA or CCIR television pictures on 16mm film. Exclusive features of the PFR-10 effectively eliminate "shutter bar" and the pattern of scan lines normally seen on television film recordings. The resulting pictures are comparable in quality to still photographs.

### TV Monitors

Monochrome monitors from RCA Professional Television combine economy and professional performance in attractively-styled cabinet and rack mounting models. Two types—the standard PX Series and the transistorized PM Series—are available in a variety of screen sizes. There is also mounting equipment to meet virtually every need.

PX Series monitors incorporate such professional features as "reduced scan" for viewing picture corners,

switchable DC restorer selection, feedback stabilization, regulated power supplies, and many other desirable extras. Both cabinet and rack-mounting models are available with 8, 14 and 17-inch screens, and a 23-inch model is available in a cabinet. An additional choice is the PXU-25C utility monitor, widely used in locations where an extra-large screen (25 inches) is needed.

Completely transistorized with the exception of rectifier, high-voltage regulator, and picture tubes, the PM Series monitors operate with nearly two-thirds less power dissipation and heat than conventional monitors. Component "heat fatigue" is thus reduced, assuring improved stability and longer life. Both 9 and 14-inch sizes are available in either cabinet or rack-mounting models.

### Video Switching Systems

PTS-1 Video Switching Systems and Modules are high-performance equipment offering "glitch-free" switching in monochrome and color. Popular applications include control rooms, mobile units, instructional TV

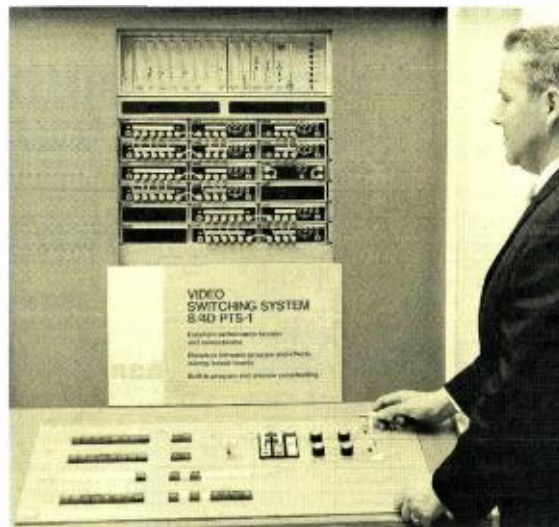

FIG. 5 Custom PTS-1 Video Switching Systems may be easily built using a variety of modules which are virtually identical in appearance. All are completely transistorized and include a self-contained regulated power supply. Shown above is the PTS-51 Module, a 5 × 1 switching module.

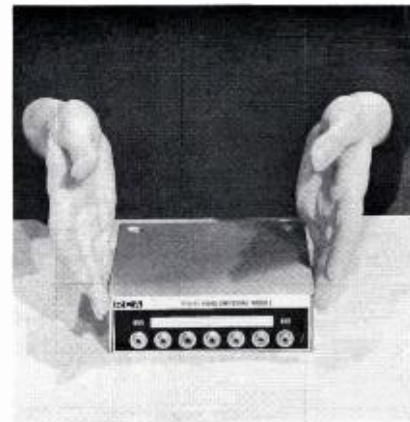

FIG. 6 PTS-1 Video Switching Systems offer "glitch-free" switching in monochrome and color. PTS-1 System 8/4D is one of ten standard systems in the line.

systems, and others. Like more expensive switchers, there is no gap or break in the signal when switching from one picture source to another, and switching is accomplished remotely by low-voltage control signals.

Capabilities of the PTS-1 Systems include switching of composite and non-composite signals, video selection with audio follow, lap dissolves, fades, special effects, tally light switching, and other functions.

Modular format is an outstanding feature of PTS-1 Systems, making the often-promised but seldom attained "building block" construction of custom switching systems a reality. PTS-1 Systems consist of compact modules which are almost identical in appearance and may be used together in many configurations to handle a variety of system requirements.

These modules, all completely transistorized and with self-contained regulated power supplies include: PTS-51 Video Switching Module, PTS-31A Video Switching Module (with output amplifier), PLA-2A Lap Dissolve Amplifier, and PDA-2A Video Distribution Amplifier. Other basic components consist of a PRA-2 Rack Mounting Shelf (accommodates three modules), a standard or custom control panel, and a PRF-1 Relay Frame if momentary contact pushbuttons are used.

PTS-1 System control panels are designed for console mounting and are located separately from the switching modules. No video is sent to the control panel, since all switching is accomplished by low-voltage control signals. The control panel and rack-mounted equipment are connected by cables having plug-in connectors. Ten standard systems are offered, ranging from PTS-1 System 8A with 8 inputs, 1 output, and lap dissolve to PTS-1 System 13/9A having 13 non-composite and 9 composite inputs, 2 outputs, lap dissolve, keyed inserts, and special effects.

### Terminal Equipment

Professional Television terminal equipment is packaged in modules having the same size and appearance as the switching modules. They handle either color or monochrome signals without degradation.

The newest addition to the terminal equipment line is the PSG-2 Sync Generator. Compact and economical, it requires only 1¾ inches of rack space and produces all four pulses needed for operation of monochrome television installations. All logic functions are accomplished by integrated circuits and the design is compatible with external accessory modules which will permit operation in full color.

The PCO-1 Pulse Changeover Switch is a compact unit offering an efficient and dependable means for local or remote transfer between television system pulse sources. Use of the PCO-1 and two sync generators will protect TV equipment against loss of pulse signals and reduce off-air time resulting from any problems that may develop in the main sync generator.

The PDA-2A Video Distribution Amplifier handles both composite and non-composite signals and can be used to add sync to its three video outputs. A re-

motely-operated sync-drop relay inhibits, on command, the addition of sync when not required.

The PDA-10 Pulse Distribution Amplifier accepts standard sync, drive, blanking, or burst flag signals; re-shapes the input signal to provide clean pulses with fast rise and decay times; and provides five 75-Ohm source-terminated outputs for simultaneous distribution of pulses to cameras, tape machines, film, or other TV units.

The Professional Television line includes three monitor switchers having 5, 10, or 18 inputs and a single output. Typical applications include camera setup and maintenance, house monitoring, master control monitoring, preview switching, and others. PMS-10 and PMS-18 switchers include multiple contacts for simultaneous switching of audio and video.

The PPG-1 Pulse Generator simplifies pulse distribution in monochrome television facilities. In a typical installation, one PPG-1 is placed in each studio or camera location. EIA or CCIR sync is the only input pulse required for the PPG-1, and it generates five output pulses (advanced sync, delayed sync, blanking, horizontal drive, and vertical drive). Because the studio sync generator is the master timing source, video signals from all cameras in the plant are locked together.

A PVD-1 Pulse Variable Delay may be placed in each outgoing sync circuit to "time" the system so that all video signals will arrive at a central location, such as master control, with the same phase relationship. PVD-1 inserts delays from 0.05 to 6.10 microseconds into pulse circuits at the touch of a switch.

### System Components

Attractive and functional, PTC Series Consoles accommodate control panels, monitors, and other control equipment on standard 19-inch rack mounting rails. The consoles are available in single, double, and triple-width models, and may be moved from room to room on accessory concealed casters. A removable front shelf permits rolling the consoles through a standard 36-inch door, making it possible to have a virtually "mobile" control room.

The TeleTitle Video Insert System offers a convenient, low-cost means for inserting captions into monochrome or color pictures. TeleTitle can produce inserts in a horizontal or vertical format, either stationary or in motion. The unit is completely self-contained with its own typewriter and television camera and may be readily taken on remotes in two sealed metal cases. TeleTitle can operate independently of station sync and special effects; composite video is the only input required.

### West Coast Headquarters

Professional Television is designed at the Commercial Electronic Systems Division plant in Burbank, California. Personnel there are also engaged in systems engineering, design and production of film recording equipment for the motion picture industry, and

FIG. 7 Newest member of Professional Television's terminal equipment line is the PSG-2 Sync Generator. It occupies only  $\frac{3}{8}$  of a rack-mounting space 1 $\frac{3}{4}$  inches high and produces all four pulses needed for operation of monochrome television installations.



FIG. 8 PTC Series Consoles are functional and attractive. A removable front shelf permits rolling the consoles through a standard 36 inch door.



design and manufacture of magnetic heads for audio, video, and instrumentation tape recorders.

### Systems Engineering

RCA representatives and systems engineers are available to RCA customers for planning, consultation, installation, and checkout of complete "turnkey" television systems. They also help station personnel train operators in the handling and maintenance of the systems.

In addition, this group designs custom-built items when needed for successful implementation of a system, prepares systems proposals, and provides direction for the systems interfacing of all Professional Television products.

### Outlook for Professional Television

The expanded use of television equipment and the increasing requirements for quality and reliability commensurate with economy indicate continuing expansion and growth for the Professional Television line. Over the past five years this line has been augmented to the extent that it now affords choice of a completely matched TV system—for either closed circuit use or broadcast. Success of the Professional equipment may be gauged by the fact that shipments last year (1967) were four times greater than 1964.



# Texas-Style Color Bus for WBAP-TV

C. D. PHILLIPS

Implementation Program Management

True to Texas tradition, the new WBAP remote unit is large and elaborate. In making his plans for this deluxe unit, WBAP's Director of Engineering, Rupert Bogan, set forth these requirements: It must handle six RCA color cameras, a custom TS-40 vertical interval switcher, two TR-70 high band color tape machines, and a special design audio system. There must be sufficient space for clients to observe operations plus plenty of room to operate. In addition, there should be complete separation of technical and production facilities with separate monitoring for each. Add to these specifications 8 tons of cooling, 18-kW of heating and humidity control. All automatic. Of course, the usual power control panel with isolation transformers, tap switches and voltage regulators—the equivalent of a sizeable building. There was just one other *minor* consideration. The "building" had to have wheels with sufficient power and gearing to travel 65 miles an hour on highways and the capability of off-road service to football stadiums, golf courses, and places of difficult terrain.

RCA accepted the challenge to design the WBAP unit to the foregoing specifications. At the outset each criteria was examined and planned separately then carefully integrated into a total concept.

## Bus Design

For the sake of ease of handling and to provide the capability of operation by station personnel, a bus design was chosen. Careful layout of the 15 equipment racks, 3 custom consoles, an operations desk and the tape machines indicated the advisability of a 40-foot single-unit vehicle—legal in the state of Texas.

When space and weight requirements were firmly established two RCA vendors were called upon to assist in the vehicle design: Jay Madsen Company, well established as experienced designer of custom chassis, and The Gerstenslager Company, who designs and builds custom bodies for mobile TV units.

Now teamwork and experience began to pay off—in the planning of wiring ducts, tapping plates to hold racks and equipment in place, placement of work and operation lights, telephones, doors, cable reels, storage space and the myriad of details that make a truly professional unit—one which becomes a tool for efficient operation by experienced personnel.

## Functional Equipment Layout

Contrary to the older less-practical approach, equipment was located for logical and efficient operation with little consideration given to weight distribution. When all the details were complete, reviewed and approved, then the actual vehicle weight distribution was mathematically determined. The required frame modulus and wheel base was computed from the weight distribution analysis.

Simultaneous with all this planning the motive power was customized to WBAP-TV requirements. A 534 cubic inch Ford engine was selected to provide a reserve of power as well as widespread availability of parts and service. The engine is married to a drive chain to match the customer requirements. In the case of WBAP, a five speed synchromesh, heavy-duty transmission, straight through in 5th gear driving an 18,500 lb. 2-speed axle. An identical dead axle is provided to carry the total weight adequately. The two

rear axles are positioned to carry their share of the load as well as assure proper loading on the 1600-lb. front axle.

### Soft Ride

Since WBAP has a reputation for technical excellence, the entire vehicle is air suspended to provide a soft ride for all the equipment. With this approach, shock mounting of individual pieces of equipment is not necessary. The soft ride concept is further aided by the use of a new line of truck tires. Instead of the usual narrow, high-pressure truck tire, a very broad tire is used, which is fully inflated at 65 psi.

A number of other advantages are derived from the use of this tire. Only two tires are required for each axle—to carry even more weight than the usual four tires per axle. Further, greater surface contact with the road enables the "wide boot" tire to provide better braking, and better brake-cooling is achieved with the single tire per drum. Better tracking, greater floatation, and improved gas mileage are all bonuses with the broad tire.

### Air Conditioning

During part of this detailed planning a third member of the RCA vendor team made a very important contribution: The Airflow Company, designer of custom air-conditioning equipment. Taken into account was the equipment power dissipation, the cubic capacity, glass area, insulation, number of operating personnel and the climate where the mobile unit is to be used—in order to design a complete air-conditioning system including cooling, heating, and dehumidification. The air-conditioning unit is designed to fit not only the specific requirements of WBAP equipment and personnel—but also the physical space allocated for it in the vehicle. All SAC specifications are met as well as additional TV requirements such as squirrel-cage blowers to provide high-volume and low-velocity air; snap action thermostat switch so there will be no picture glitches; hot gas bypass and constant running to reduce power load variations; and shock mounting of all components to reduce to the minimum noise and vibration.

### Ready This Summer

Incidentally, long experience in building more mobile units than anyone else in the business, plus the development of a responsible, reputable design team, makes it possible for RCA to build mobile units exactly for the customer's requirements—be it large or small. These are usually completely equipped and wired before being turned over to the customer. This WBAP-TV mobile unit, however, will be delivered by RCA for installation of the equipment and wiring under personal supervision of Director of Engineering Rupert Bogan, employing diagrams prepared by RCA engineers. Scheduled operational date is Sept. 1, 1968.

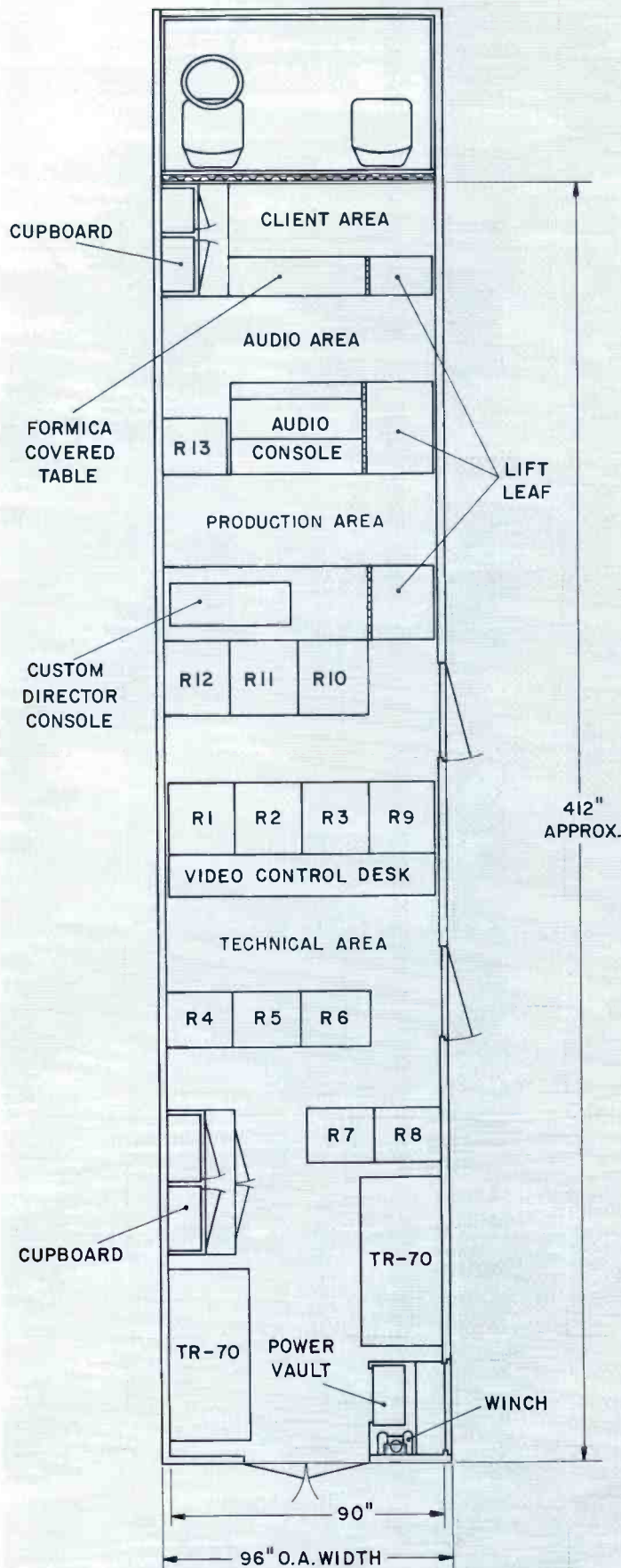



## COLOR INCREASES ATTENTION, IMPACT, RECALL FOR WBRA-TV

JANET ROSEN  
Publications Editor, WBRA-TV

Using RCA Color Cameras, Film System, High Band Recorders and 30-KW UHF Transmitter, Station Serves 90,000 Students Daytime, Has In-Service Training for Teachers, and Programs for Total Community in Prime Time



Educational broadcasting has begun to mount the crest of a long deserved wave of progress in the United States. WBRA-TV, Roanoke, Virginia, represents the newest of the new look that has come to ETV with the worlds first ETV station to be designed and built specifically for full color. One of the finest ETV facilities now in operation, WBRA-TV-Channel 15, a community owned station, began telecasting on August 1, 1967. As the 143rd ETV station in the nation, it is a far cry from the converted garages, warehouses, bakeries and backrooms which have been the bane of too many pioneer ETV broadcasters. However, as progress is made in implementing further live interconnections and program exchanges between ETV stations, there will be greatly increased demands for production facilities like those at WBRA-TV.

Channel 15 has a potential audience of one million viewers according to a projection by the National Association of Educational Broadcasters. The station plans to develop a uniquely local appeal to this audience by originating the majority of its programming from the new studios. The heavy production loads anticipated will demand greater flexibility and utilization of equipment than is required by most stations that rely heavily on network offerings.

WBRA-TV is operated by the Blue Ridge Educational Television Association. This non-profit corporation was organized in January of 1966 and is composed of a membership of contributing school districts. At present Channel 15 serves 19 school districts in the Roanoke Valley, reaching 90,000 school children with classroom television lessons.



FIG. 1 Studios and office building of WBRA-TV in Roanoke, Va.



FIG. 2 Ralph Rosen, Production Manager, and Ercil Rexrode, Jr., Chief Engineer watch as Benton O. Dillard, Mayor of Roanoke, presents key to the city to E. Dana Cox, Jr., Vice President and General Manager of WBRA-TV.

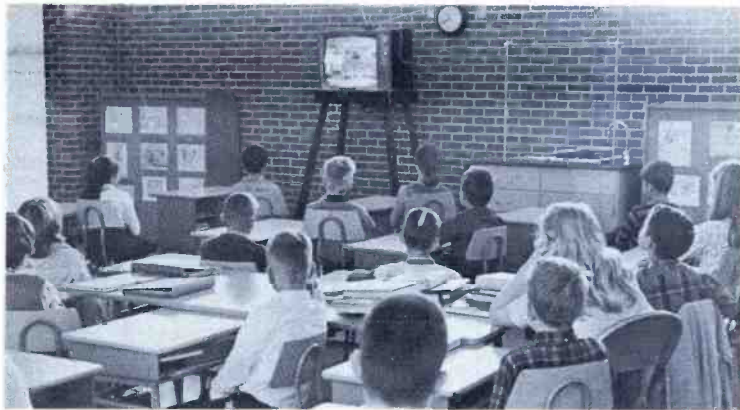

FIG. 3 Pupils in elementary school view a class in art from WBRA-TV.



### Color Increases Learning

As pioneers in color ETV instruction, the station's staff confirms the findings of commercial broadcasters: that color aids in increasing attention, impact and recall . . . all important factors in the learning process.

Furthermore, now that many youngsters are becoming accustomed to having color television in their homes, they can hardly be expected to look forward to the traditional black and white reception in their schools.

In spite of increasingly heavy production loads, set-up time has been kept at a minimum for both camera and lighting. Standardization of procedures and good coordination between studio and video control personnel have streamlined production operations, without sacrificing quality.

WBRA-TV's Production Manager, Ralph Rosen, says, "Our technical set-up time isn't taking appreciably longer for color than it would for black and white. We generally shoot at about 350 footcandles and, of course, total Colortran quartz lighting has been extremely helpful in economies of time. The important thing with color in instruction is not to prejudge what can or cannot be done. Since we are



FIG. 4 Frequent visitors to WBRA-TV's studios are the students who watch instructional programs from Channel 15 in their classrooms.

FIG. 5 Staff artist, Patt Gaffga, prepares a model scene for daily children program.

experimenting in a new area, we can't let the untried scare us off. We have to use the color and not let it use us. Color opens a whole new dimension to television teaching. I defy anyone to view one of our art programs in color and ever be satisfied with monochrome again."

### Programming

To best serve its viewing area, WBRA-TV presents both a full schedule of daytime classroom programs and evening programming designed to meet the varied needs of the whole community.

Five days a week, Channel 15 televises school lessons from 9:00 a.m. to 3:45 p.m., as well as utilization and in-service training courses for teachers. The elementary school schedule consists of courses in science, mathematics, art, music, language arts, and Virginia geography. On the secondary level, English literature and language, mathematics, and economics courses are offered.

The studio teaching staff consists of six carefully chosen professional teachers. Courses offered were selected by curriculum committees composed of representatives from the member school divisions. For

each course a complete outline and teacher's guide is prepared in advance and supplied to the classroom teachers.

The station also offers programs in Adult Education, meeting the needs of people in business, agriculture and medicine.

### Community Programming

During the evening hours from 5:00 p.m. to 11:00 p.m., WBRA-TV presents a full range of general audience programming. It originates approximately 6 hours a week with a daily children's program and numerous weekly series including: popular and classical music, interviews, discussions of literature and current events, and a telephone participation program. Because of the many varied program sources throughout the community, WBRA-TV also frequently presents special programs which capitalize on the many good single program ideas unused by other local stations.

An expanding local evening schedule is being developed through a growing membership of individuals and businesses who contribute to the support of WBRA-TV.

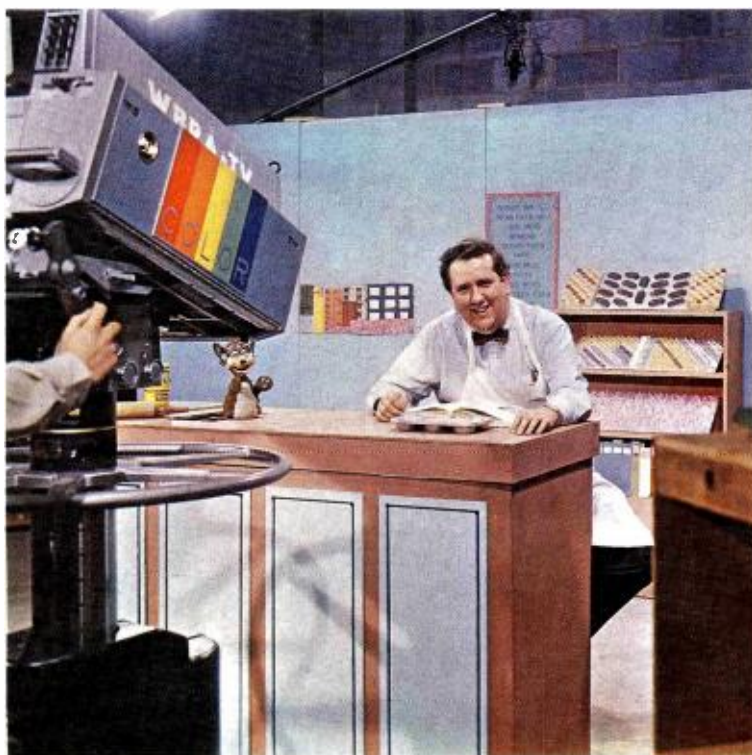

FIG. 6 Daily local children's program set in a candy store features songs, stories, and handcraft projects. Candy store proprietor is "Candy Cane Laban Johnson".

Program areas in the planning stage include: drama, dance, sports, documentaries which explore both current problems and the unusual social and historical wealth of Virginia, and programs that will introduce viewers to a variety of leisure time activities.

Total community involvement is being sought through cooperation with many civic and social organizations since the station plans to remain sensitive to the needs and desires of its audience.

Channel 15 is also an affiliate of The National Educational Television Network and selects from their program offerings as well as those available from Educational Television Services and The Public Broadcast Laboratory.

### Planning

WBRA-TV had its beginning in October of 1964 when the Roanoke City School Board asked State Representative William Meredith, a member of the Governor's ETV Advisory Council, to select a committee of at least 25 business and educational leaders to study and make recommendations for bringing ETV to the area.

In May of 1965 the committee reported back to the School Board recommending that the Board assume leadership in organizing a steering committee to develop plans for establishing an ETV facility. Three days later such a committee was formed and held its first meeting.

During the ensuing months, the committee worked out the operational and financial aspects of the proposed facility and drafted Articles of Incorporation. In October representatives of all the school divisions in the coverage area were invited to attend an organizational meeting. They were presented with the committee's plans and invited to join the Association. In January the Blue Ridge Educational Television Association was officially incorporated and 15 school divisions had joined.

E. Dana Cox, Jr. was named Vice President and General Manager and came to Roanoke in April to begin setting up the actual facility.

### Building

Ground was broken for the station in November of 1966. The building sits on a hill amid a park-like wooded area. The site was donated to the Association. The land is part of a large area left to the City of Roanoke by Blair J. Fishburn. Its use by the station was voted by the Roanoke City Council and approved by the heirs of Mr. Fishburn. At the dedication ceremonies, a bust of Mr. Fishburn was unveiled in front of the station.

Completed in June of 1967, the building was dedicated in September. The speakers at the specially televised ceremony included: Samuel P. McNeil, President of the Blue Ridge Educational Television Association, and a prime mover in the Association's

founding; and Chalmers Marquis, Executive Director of Educational Television Stations, a Division of the National Association of Educational Broadcasters.

Rough plans for the building were made by Vice President and General Manager, E. Dana Cox, Jr., and Chief Engineer, Ercil Rexrode, Jr. Working from these plans, the architects, Smithey and Boynton of Roanoke, designed the building, fitting it beautifully into its wooded background. The general contractor was Days Construction Company of Roanoke. Construction of the \$1,428,000 installation was financed by funds from three sources: 50% State, 33% Federal Government (Department of Health, Education and Welfare) and 17% local.

Containing 14,000 square feet, the station was designed for maximum flexibility and utilization of space. The office areas were located in a series of departments, so that all closely related functions were placed in adjacent locations. Light colors and bright, modern furniture set the keynote in these areas.

Temperature control, of prime importance in a color operation, was carefully planned. The building has an air conditioning compressor capable of 100 tons of cooling. Each studio has its own separate air handling unit with a third unit for the office area. These have completely separate controls to maintain exact temperature regulation in each area at all times.

### Production Areas

Of the \$822,000 invested in equipment, \$780,000 is in RCA broadcast equipment. RCA was chosen because of the high quality on-the-air results, compatibility of all components, ease of maintenance, and excellent service.

### Studio Areas

There are two studios, each with a 28 foot ceiling. Studio A measures 40 by 60 feet and Studio B, 40 by 40 feet. There is also a potential third studio area the same size as Studio B which is now used for making and storing properties.

Studio A has two RCA TK-42 color cameras and Studio B has two RCA TK-60 black and white cameras. Covered trenches run around each studio carrying all cables out of sight, yet easily accessible for maintenance.

### Lighting

All lighting is Quartz-Iodine with patch panels designed for future installation of dimmers. The lighting installation was done completely by station engineers and planned specifically to meet the unique needs of an ETV color operation. Each studio has 400 ampere service for lighting with 102 outlets in Studio A and 80 in Studio B.

### Control Rooms

Each studio has its own control room and glass en-



FIG. 7 NET Playhouse is one of many outstanding program series aired by WBRA-TV through its affiliation with National Educational Television Network.



FIG. 8 40' x 60' color studio during preparation for popular live telephone participation show, "Nightline". Two TK-42 color cameras are shown.

FIG. 9 40' x 40' monochrome studio "B", is equipped with two TK-40 Cameras.

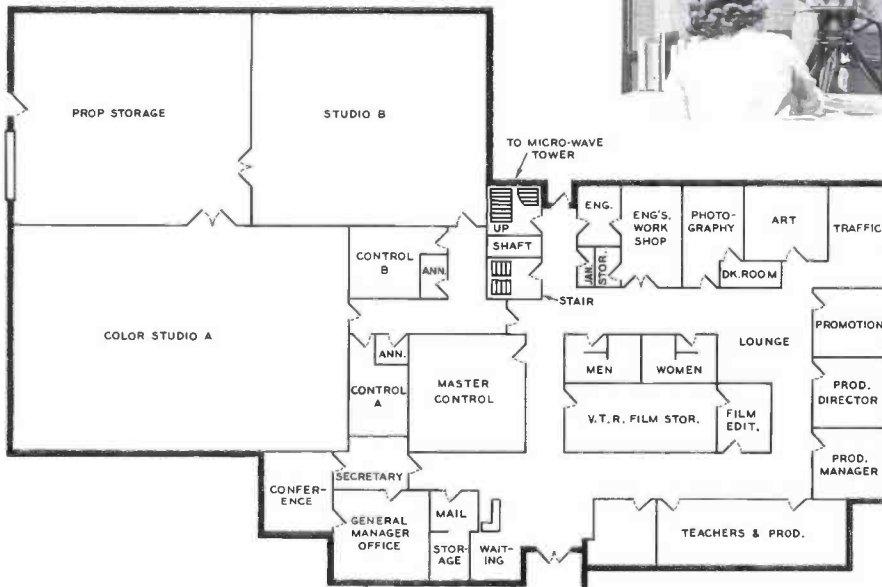

FIG. 10 Floor plan shows WBRA-TV's excellent layout of studios, control rooms, offices, and supporting functions.

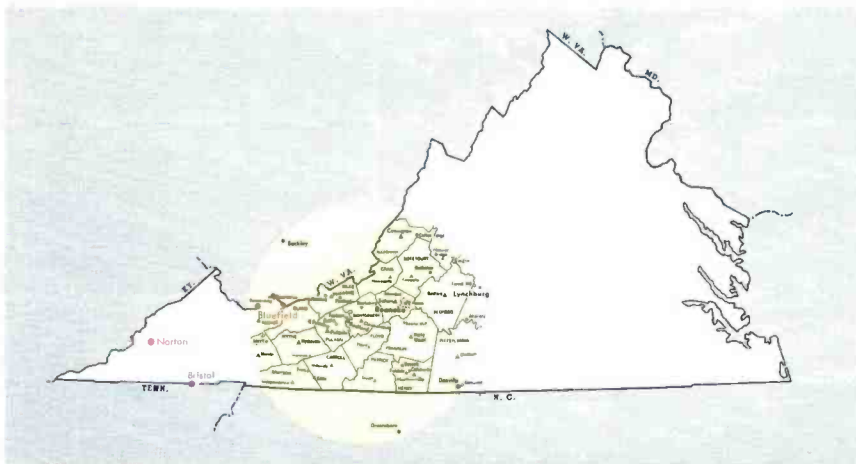

FIG. 11 Map of Virginia shows present coverage area of WBRA-TV and locations of three planned satellite stations to cover western portion of the state.

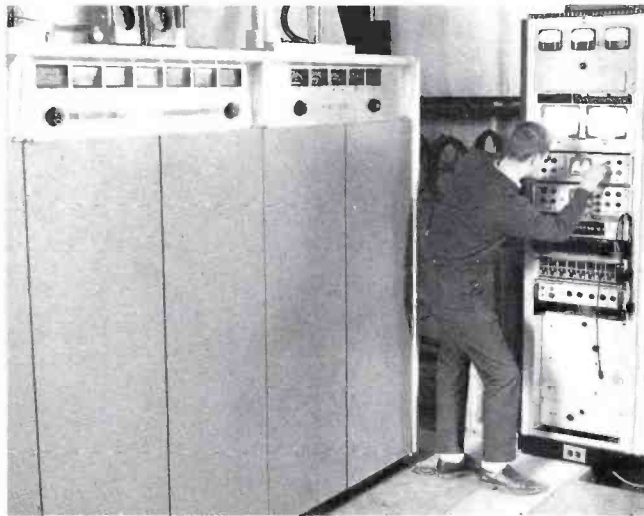

FIG. 12 The TTU-30A (30 kW UHF) transmitter is housed in a separate 24' x 48' pre-fab metal building.

FIG. 13 Film crew shoot color documentary footage for local program on airport noise problems: "Roanoke in the Jet Age". Producer-photographer Jon Boettcher and host Ralph Rosen.



FIG. 14 A model kindergarten is shown for a project recorded for the Roanoke city schools.

FIG. 15 Mrs. Betty Tisinger, art teacher, prepares her program for grade school students.



closed announcer's booth; both can be in operation simultaneously. Each control room is equipped with an RCA RT-7 audio-tape player and recorder, a BC-8A console, and a PTS-1 switching system using an 8/7 switching arrangement. All four cameras are fed into each control room switcher to increase flexibility. In addition to being connected by headphone to master control, cameras, etc., control room personnel can also use a loud speaker, talk-back system to communicate with studios and master control room.

### Master Control

The master control room measures 20 feet by 25 feet. Here is located the controls for all studio cameras, a film chain using an RCA TK-26 Color Film Camera, two TP-66 film projectors, and a TP-7 slide projector. The rack equipment is housed in six racks and includes an RCA TVM-6 microwave transmitter, two

TG-3 sync generators, and 24 distribution amplifiers.

Three RCA TR-4HB high band tape recorders are also located in master control. A separate air compressor is mounted in the basement to feed compressed air to each machine. Each machine has its own internal air compressor, which can be used in case of failure of the main air supply. All three TR-4HB's can be in use at the same time, two recording and one on-air.

A completely self-contained master clock system by Favag is installed with the master clock in master control and slave units in each control room and studio.

### Microwave

A six foot microwave "dish" is fed through a wave guide from the RCA TVM-6 microwave transmitter in master control. The 33-foot microwave tower is adjacent to Studio B.



FIG. 16 Each studio has its own control room as shown above, containing the BC-8 audio console, PTS-1 switching system, remote controls for VTRs and film chains.

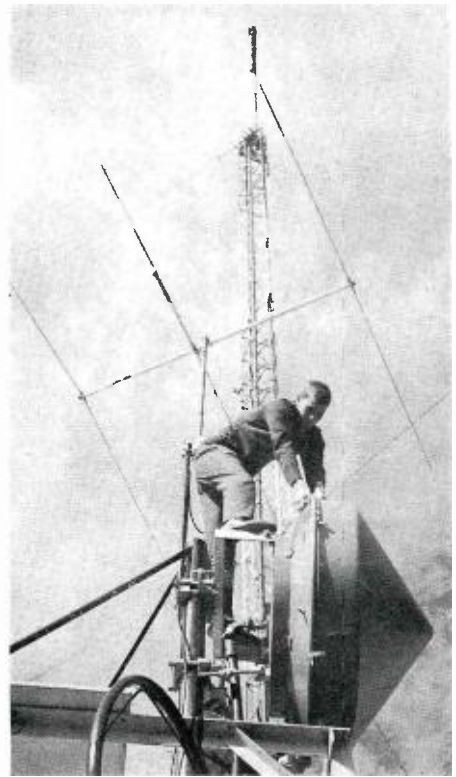

FIG. 17 View of TVM-6 microwave receiver "dish" with the TFU-30J antenna in the background.

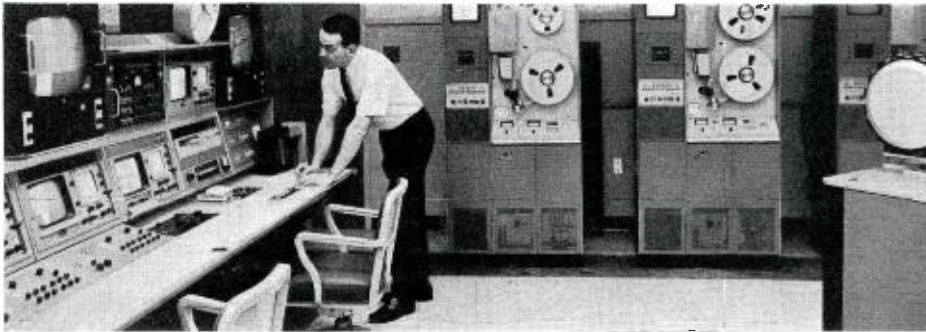

FIG. 18 Ronald Smith is shown in the master control area which contains three TR-4HB recorders, camera controls, and film chain.

## Transmitter

Land for WBRA-TV's transmitter was donated by WSLC-TV, a Roanoke commercial station. Eleven air miles from the station, the transmitter is located atop Poor Mountain, which is 3732 feet above sea level.

The Type TTU-30A 30KW UHF Transmitter is housed in a 24 by 48 foot pre-fab metal building. Atop the 200-foot tower is mounted a TFU-30J antenna at an overall height of 3995 feet above sea level. Maximum radiated visual power is 631,000 Watts and coverage is excellent in spite of the rugged terrain in most reception areas.

## Future Plans

On July 1st a second transmitter will go into operation in Norton, Virginia. It will be fed by a 150-mile two-channel microwave unit consisting of 7 hops. This

will extend WBRA-TV's school programming to five more school districts and add 47,000 classroom children to the viewing lists.

Norton is located in southwestern Virginia, a region which has different program needs than the area now served by Channel 15. Therefore, the parent station in Roanoke will feed Norton with some specialized programs designed specifically for that new coverage area.

Norton is the first of three planned satellite transmitters. The other two will be in Bristol and Bluefield. Because of the diversity of the audience in this large geographic region, many new challenges face WBRA-TV in meeting the needs of Virginia citizens. Through strong local programming, this new station plans to become a leading force in the public television movement, providing enlightened programming for an area long without the benefits of ETV.

# The moment you begin to radiate 5 million watts of UHF...

## *Madison Avenue gets the picture*

RCA has a new transmitter-antenna combination with the kind of radiated power that reaches Madison Avenue. We call it Omni-Max (maximum UHF in all directions). Put it on-air, and you get five million watts of effective radiated power. On Madison Avenue that means coverage, and coverage means sales.

And there's more than just that. You protect your investment. You cover the outlying towns before somebody else does. Nobody can "outpower" you.

The new UHF transmitter is RCA's TTU-110A. It delivers 110 kilowatts of output power. The new UHF antenna is the Polygon. It is a high gain antenna. It will radiate five megawatts. In short, with this maximum power allowed by the FCC, you have the means to take over the territory. And you hold it!

Call your RCA Field Man. Tell him you'd like to turn on Madison Avenue. He'll show you how five million watts of ERP UHF can reach the people who buy the time. Isn't that the kind of performance you really want? RCA Broadcast and Television Equipment, Building 15-5, Camden, N.J. 08102

# RCA

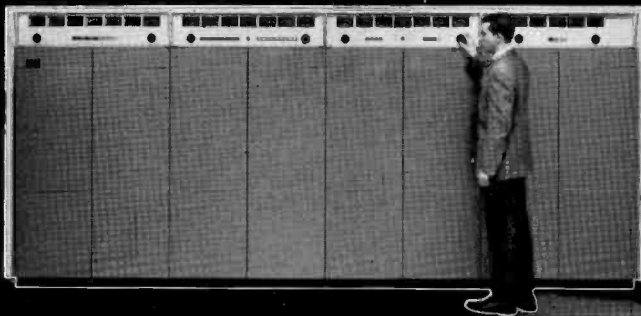

The RCA Omni-Max system is the most powerful UHF antenna-transmitter combination you can buy. The transmitter is RCA's TTU-110A, featuring diplexed amplifiers with efficient vapor-cooled klystrons. Ready for remote control. Combine it with the new Polygon five-sided Zee-Panel antenna, which features uniform pattern, excellent circularity for super-gain UHF.







## Electronic learn-in

Susan and Bobby are practicing a French dialog for extra credit. Eddie is making up a lesson he missed yesterday. And, the rest of the class could be working on seven other languages or lessons.

This profile of activities in one room demonstrates the versatility a teacher can attain, with pushbutton simplicity, via today's RCA EDC-101 Electronic Learning Labs.

The EDC-101 brings to the electronic learning lab the kind of convenience automatic drives introduced to automobiles. The teacher's console groups student position controls in the same layout as the student seating plan.

RCA "Lesson Override" enables the teacher to communicate with selected student positions while a recording is playing—without disturbing other students. And, students can be grouped by progress level or subject. The EDC-101 can play 10 different lessons simultaneously.

More individualized instruction in large classes, via an RCA EDC-101 system, changes classwork from a sit-in to a learn-in.





## NEW kind of automatic threader...

### IT'S THE SAFE THREADER

The RCA 1600 can thread a film leader in less than 5 seconds—which is what you expect from an automatic threading 16mm projector. But when you're showing a film, it's what follows the leader that counts. And it's here that the 1600 makes the big difference.

Because this projector has a *disengageable* self-threader. It means that once the leader is on, the RCA "Safe-Threader" never touches the film. In fact, you can even remove the threader while the projector is running.

This "no-touch" approach means extra safety and convenience. With the threader off, you're in complete control. You can unthread or rethread the film in seconds. You can "Rewind" a partially shown film. Or clean the lens and film gate—all exactly as you would on a manual threading projector.

So if your school requires a self-threading projector, be sure to get one that works on the leader and not on the film. We call it the "Safe-Threader." It's optional equipment, and sensibly priced, too.

The "Safe-Threader" is one of dozens of exciting accessory items for the RCA 1600—all designed to make a great projector even better. For complete details or a demonstration, contact your RCA Audio-Visual Distributor. Or write RCA Instructional Electronics, Building 15-5, Camden, N. J. 08102.



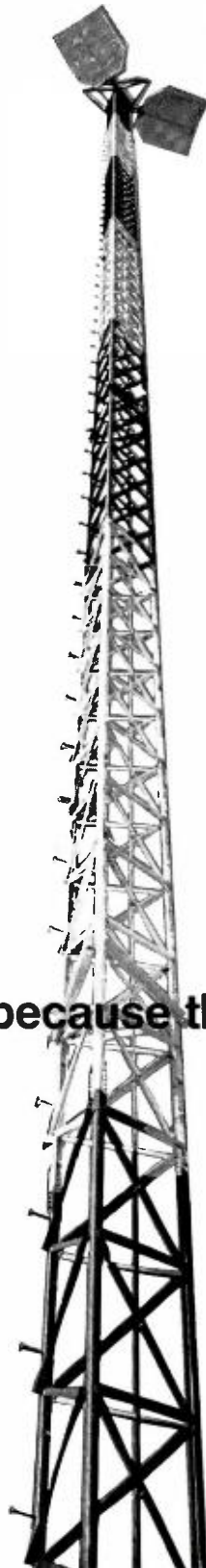

## They won't shut up because they won't shut down

**After 23 years of designing and installing microwave, 95% of all RCA-equipped stations are still going strong.**

RCA microwave just never seems to wear out . . . and we have 23 years of operating experience and thousands of microwave stations to prove it. From small one-hop systems to cross-continent, high density networks, RCA microwave is an around-the-clock performer—transmitting voice, data, telemetry and supervisory control signals.

And it's 23 years better today. That's because today's RCA microwave is total solid state design (an RCA first), which means no tubes to burn out and no relays to fail. Heterodyne operation (RCA pioneered that, too) brings in clear signals, eliminates distortion.

If you are planning a microwave system, shouldn't you look into RCA microwave? Send for literature, or better still, request a planning consultation with an RCA microwave expert. He will show you what a difference 23 years of experience can make.

**Here are just a few leading organizations who rely on RCA Microwave:**

**American Electric Power  
California Division of Highways  
Chicago & North Western Railway  
El Paso Natural Gas  
Empire District Electric  
Los Angeles Police Department  
Santa Fe Railway  
Shell Oil**

# We challenge any other 2-way radio to transmit continuously over 2 years without component failure.



**An RCA Super-Fleetfone passed this test . . . and is still going strong.**

Ordinary 2-way radio equipment would fail or go off the air within minutes if the transmit button was pressed continuously. Compare this to the more than 17,700 hours (over 2 years) that the RCA Super-Fleetfone has been continuously transmitting with only an 8-second break every 5 minutes to test the reliability of the antenna switch. There hasn't been a single component failure or the slightest degradation in communications performance.

The secret of this kind of stamina is RCA advanced transistorization that delivers greatest reliability even under the stress of continuous transmission. There are no tubes to burn out, no relays to wear out. And the rugged design can stand up to the toughest vehicle vibration.



You get more for your investment when you specify RCA 2-way radio—more air time, more communications, more quality. Get all the facts about RCA Super-Fleetfone, the only standard 2-way radio that's rated for continuous duty transmit.



## Command Performance?

**RCA SERVICE DELIVERS**

**Expert Repair and Overhaul Service**

FOR: ■ Video tape recorders  
■ TV Cameras  
■ Antennas  
■ Microphones  
■ Transmitters  
■ Installation  
■ Console  
■ TV Projectors  
■ Microwave

For full information about fast dependable  
broadcast equipment maintenance service  
from RCA, call either of these offices:

Chicago (312) WE 9-6117

Philadelphia (215) HO 7-3300

Or write:

**RCA SERVICE COMPANY**

A Division of RCA

Technical Products Service

Bldg. CHIC-225, Camden, N. J. 08101



"Noiseless" Colors

**Tape the color "toughies...  
play them like live"**



...With the RCA TR-70  
High Band Recorder

The TR-70 is the high band television tape recorder for unexcelled performance. It's truly the world's most sophisticated system . . . it makes even the tough jobs in taping easy to accomplish. It delivers up to four generations of *brilliant, broadcastable color* without a trace of tattle-tale grain.

"NOISELESS" COLORS . . . even with yellow—the "noisiest color" around—you'll get a noise-free picture. The TR-70 delivers the greatest, most noise-free yellow you've ever seen—yellow, without even a whisper!

**At RCA our new  
corporate symbol  
is really a minor change  
compared with  
the innovations  
it will signify  
in decades to come.**

**RCA**